

INSTALLATION MANUAL
2023 + Ford Super Duty Pickup

TRU-SPEED

Patent Pending

TRU-SPEED corrects the vehicle speed when larger or smaller tires which are unsupported by the OEM are installed on a truck.

Serious off-roading requires tires larger than those offered by the OEM truck builder. Larger tires often create problems for the truck's electronic systems. On late-model trucks, the vehicle speed is calculated by the tire size and revolutions per minute. Various systems installed on the truck use the vehicle speed to determine performance parameters. An incorrect vehicle speed can alter the performance of the truck and, in addition, cause errors and dash warning lights. Also, the speedometer and odometer readings need to be corrected.

TRU-SPEED corrects the vehicle speed seen by all the systems on the truck, including the speedometer. The system is installed between the wheel speed sensors and the ABS module.

In the past, upfitters installed a small module behind the instrument cluster, which only corrected the indicated speed of the speedometer. TRU-SPEED, however, corrects the speed for all modules, providing a comprehensive solution for accurate vehicle speed readings. This makes TRU-SPEED a superior choice for truck owners seeking to correct speed discrepancies caused by tire size changes.

TRU-SPEED, a versatile solution, can be easily calibrated for a wide range of tire sizes, from smaller tires to larger off-road tires. This straightforward installation ensures truck owners can confidently use TRU-SPEED to correct speed discrepancies caused by tire size changes. Currently, it is available for the 2023 Ford SuperDuty, with plans for development on other medium-duty trucks

Kit Contents

- 1pc—Wheel Scaler Module
- 1pc-Mounting Bracket
- 1pc-6mm Serrated Flange Nut
- 1pc—Deutsch DTM06-6S Connector
- 1pc—Deutsch DTM06-4S Connector
- 10pc—Deutsch 0462-201-20141 Female Connector Pins
- 1pc—Deutsch WM-4S Connector Lock
- 1pc—Deutsch WM-6S Connector Lock
- 1pc—18AWG Red Wire 6”
- 1pc—18AWG Black Wire 6”
- 1pc-18AWG Yellow Wire 4”
- 1pc-Heat Shrink

Scope of Work

Installation of the first design of the TRU-SPEED requires removing the left front wheel liner, disconnecting the ABS connector and the left front wheel sensor connector, opening the harness and separating out the four ABS wheel sensor twisted pair wires, cutting the sensor wires and terminating with a Deutsch Connector, connecting power and ground, closing the harness, and reinstalling the removed components. Some expertise in automotive wiring is required.

Review These Instruction Before Beginning Installation

Tools Required

- Deutsch Crimpers
- Good Quality Wire Strippers
- 5.5mm Socket
- 7mm Socket
- Good Quality Electrical Tape—3M Scotch Super 33+
- Soldering Iron
- Solder 60 / 40 Rosin Core
- Push Pin Remover
- Needle Nose Pliers

SAFETY FIRST



Securely Chock the wheels



Firmly Set Parking Brakes



Place the Keys in Your Pocket



Disconnect the Negative Terminal
at Batteries

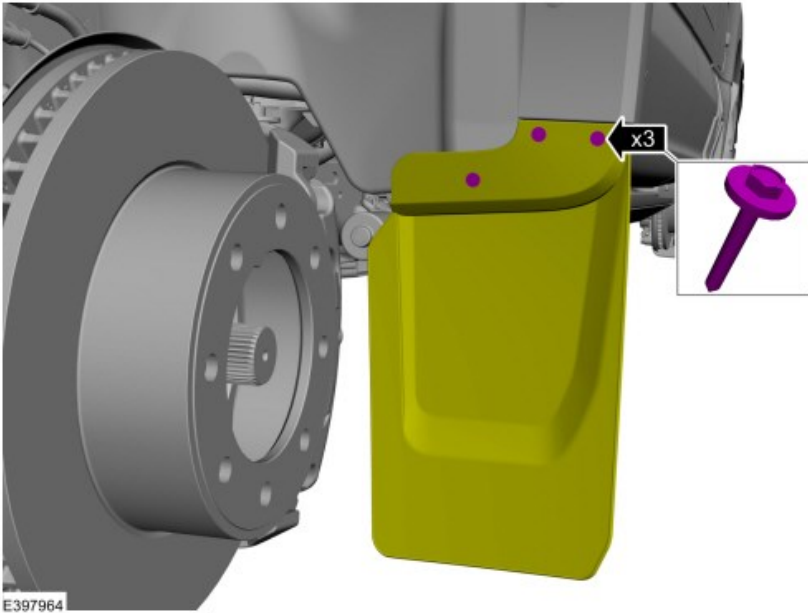

If equipped with mud flaps,
use a 7mm wrench to
remove the three bolts.

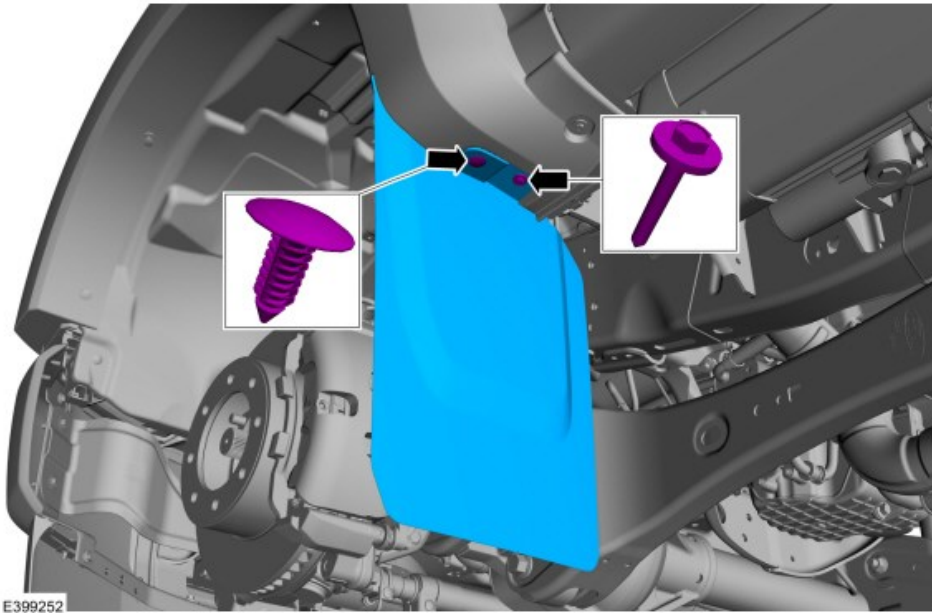

If equipped with mudflaps,
remove the pushpin, bolt, and mud flap.

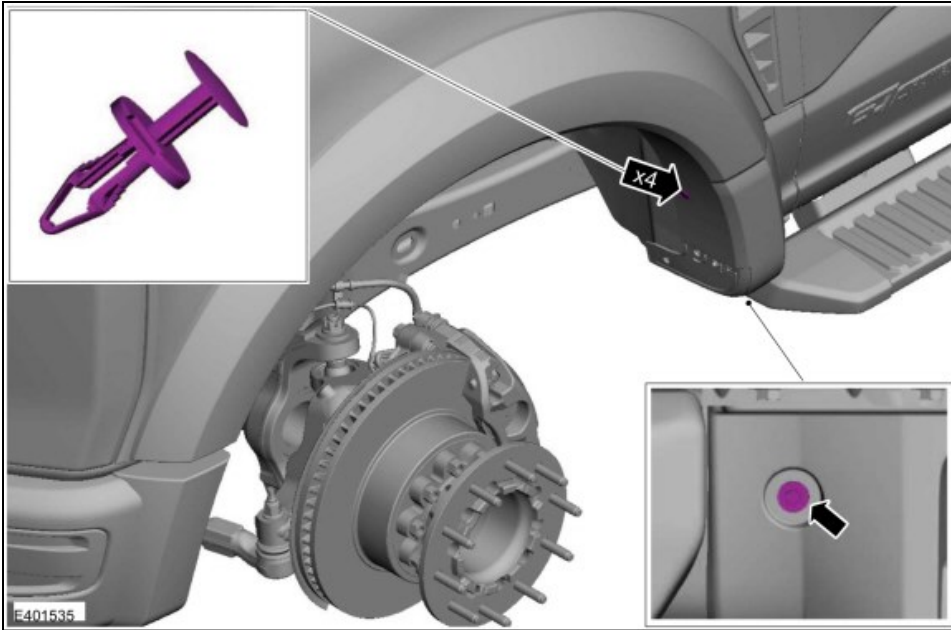

Remove the four push pins and the retainers attaching the wheel lip to the fender.

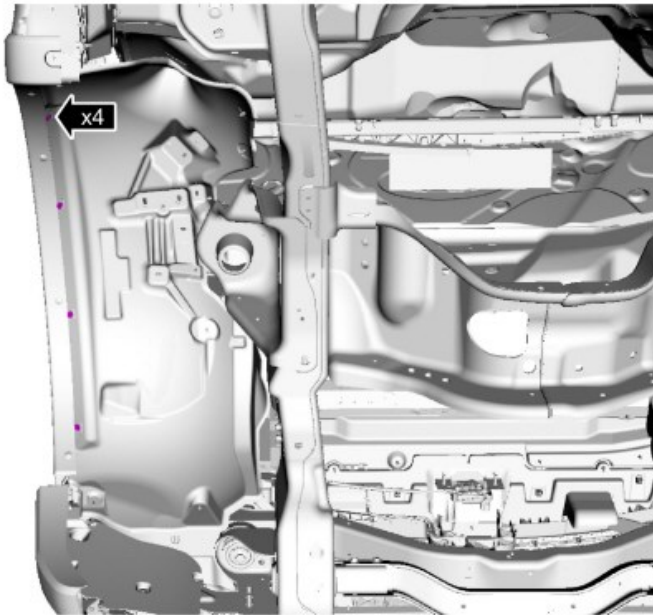

Using the 5.5mm socket, remove the four screws retaining the wheel liner. The screws are located just inside the wheel lip.

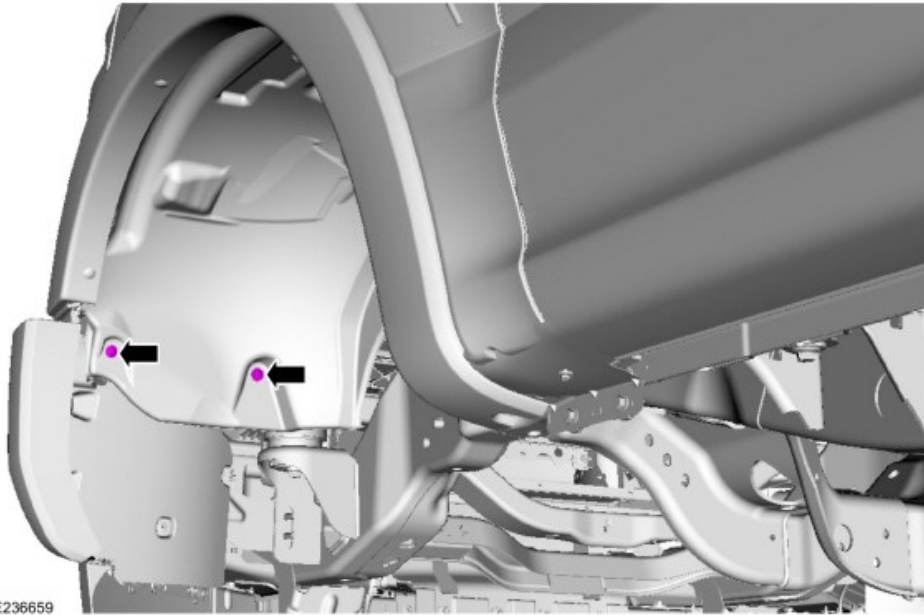

E236659

Using a 10mm socket, remove the bolt and push pin.

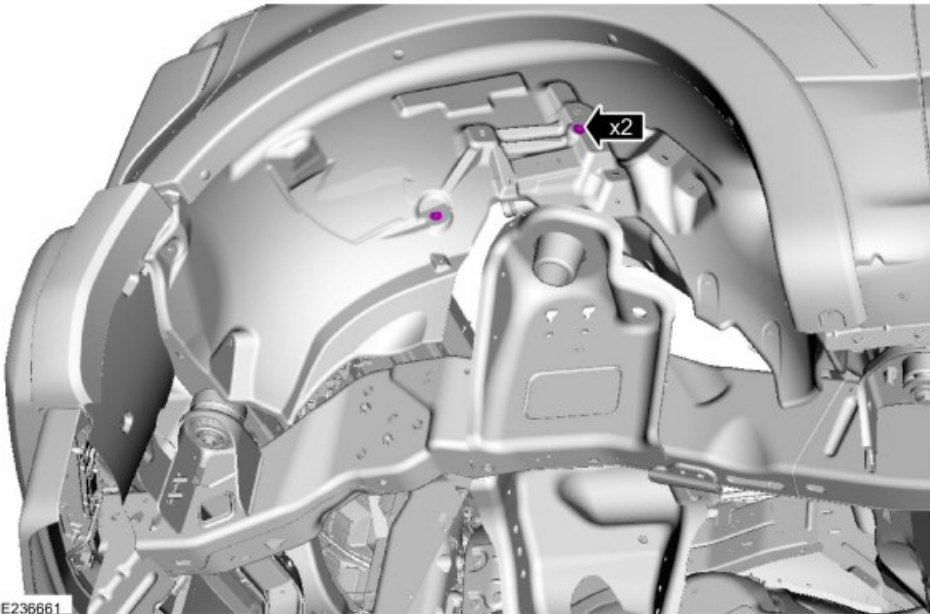

E236661

Using a 10mm socket, remove the two bolts.

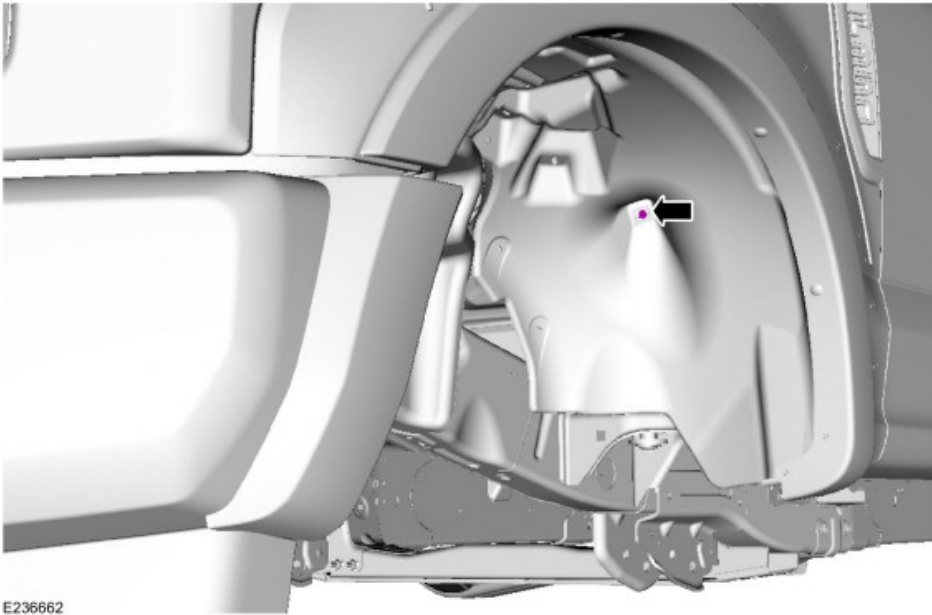

E236662

Remove the nut.

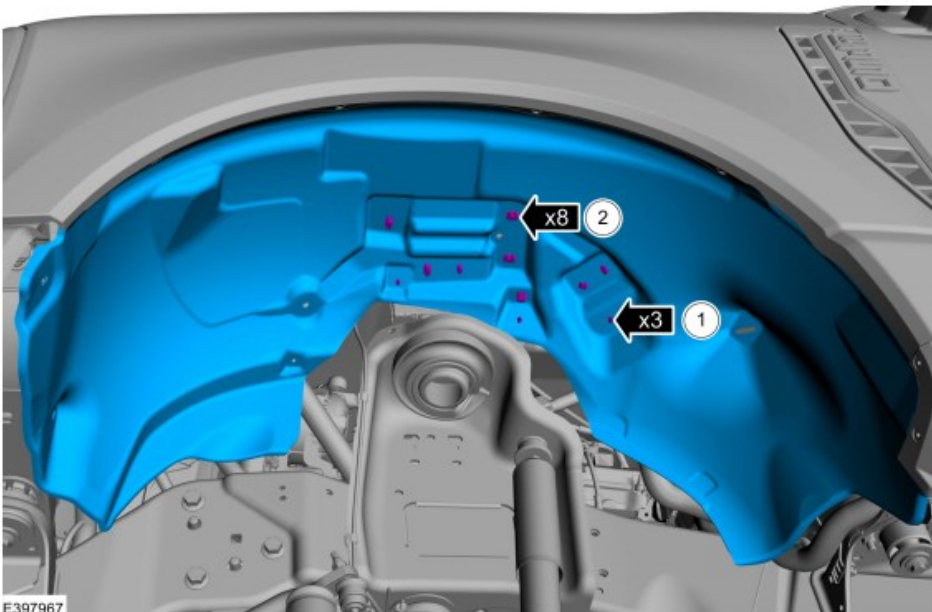

E397967

1. Push the hood latch release cable retainer up through the liner. 3 times
2. Release the wiring harness retainers by pushing the retainers up through the liner. 8 times
3. Remove the liner from the wheel opening.

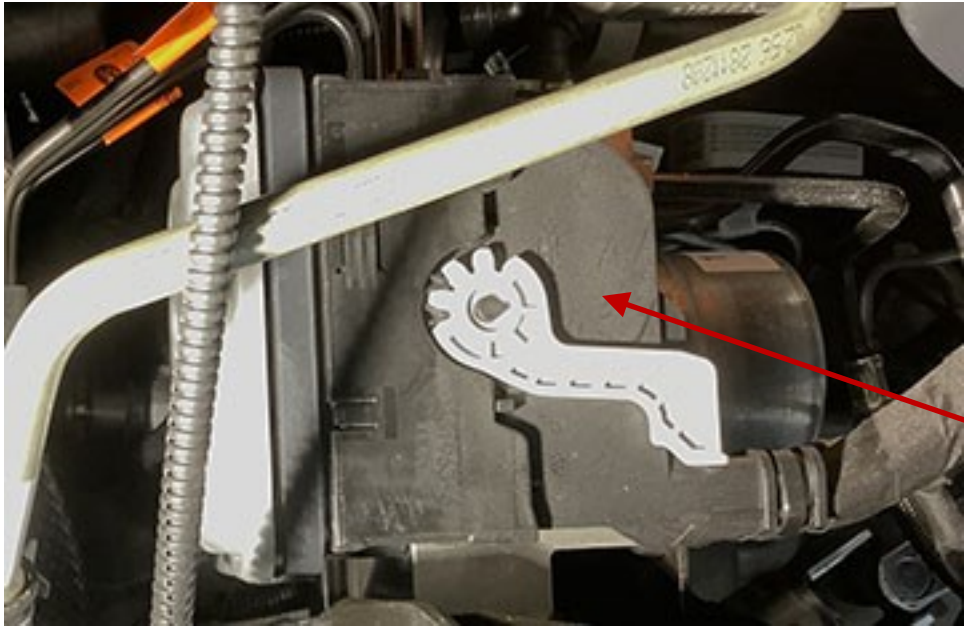

The ABS Module is located on top of the left front axle spring tower, and accessible with the left inner wheel liner removed.

Remove the ABS connector from the ABS module.

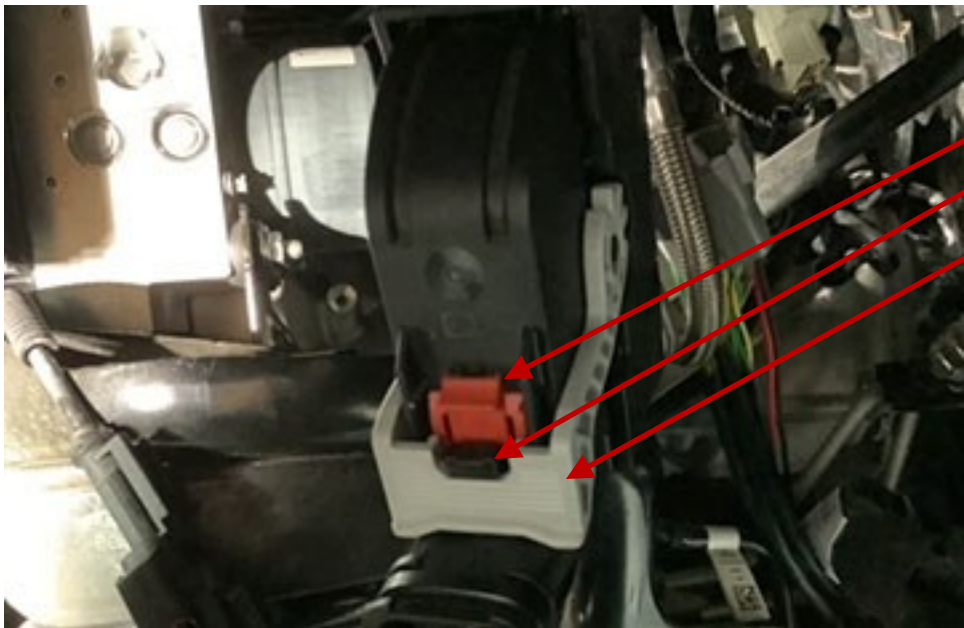

Lift the red lock.

Push the black tab and

Lift the gray lever.

Using a push pin remover, remove the left front wheel sensor connector from the base of the ABS mounting bracket.



Separate the connector by sliding the red lock away from the connector and pressing the black tab behind it.

Pull the ABS connector and the wheel sensor connector into the wheel well area.

Remove the tape from the harness split to the ABS Connector.

Also, remove the tape around the wheel speed connector.

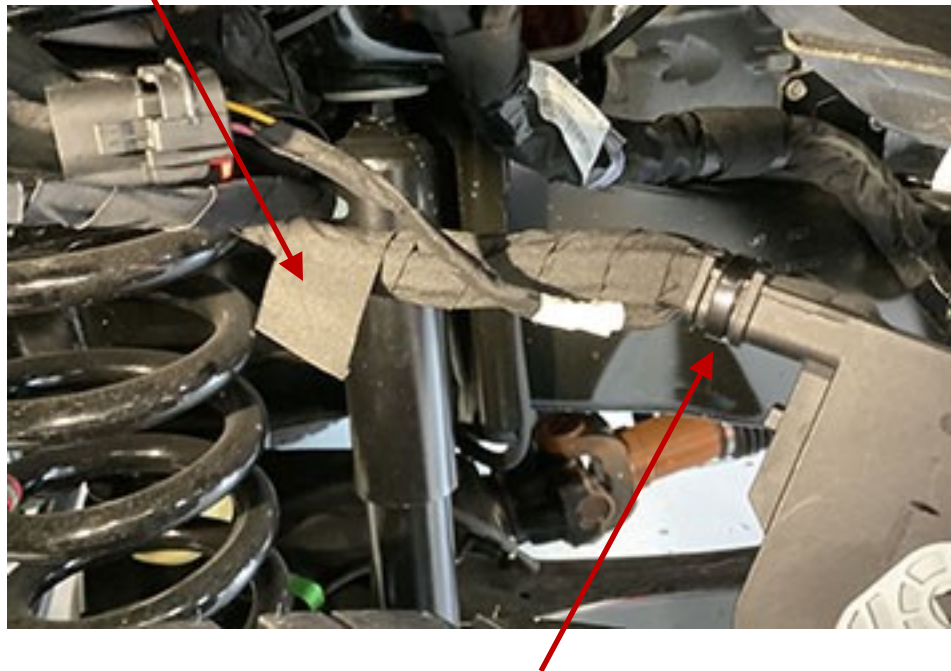

Remove the nylon tie.

In the unwrapped harness, you will find five twisted pairs, including the left front wheel sensor pigtail.

Cut the wheel speed signal wire (one wire in each pair) about 3" from the ABS connector.

2023+ Pickup Truck

Yellow/Grey wire in the Yellow-Grey—Violet/Orange pair—Left Front Wheel

Green/Orange wire in the Green/Orange—Grey/Brown pair—Right Front Wheel

Brown wire in the Brown—Blue pair—Left Rear Wheel

Brown/Blue wire in the Brown/Blue—White/Blue pair— Right Rear Wheel

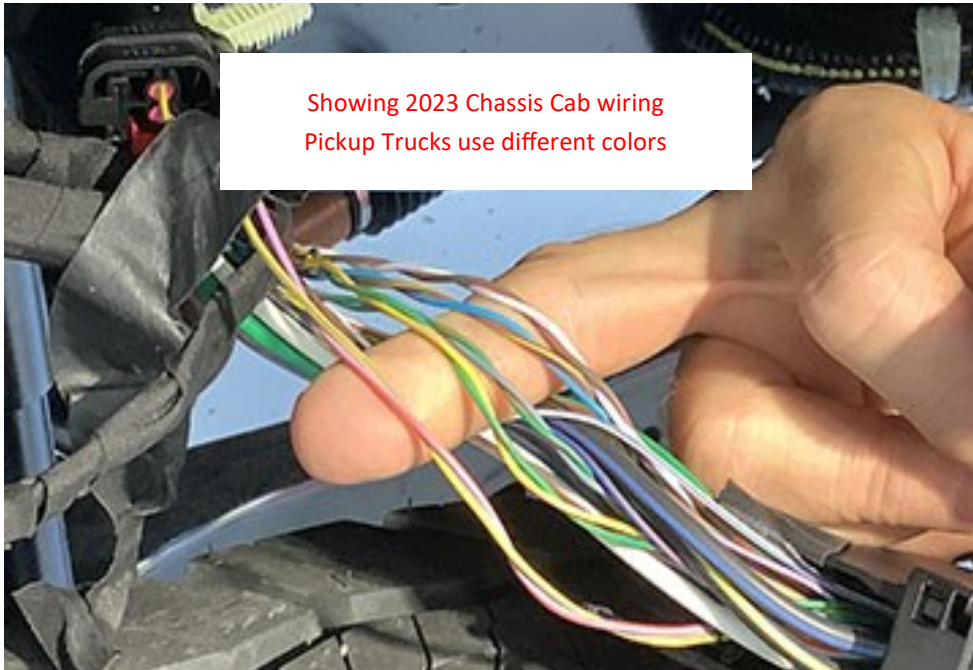

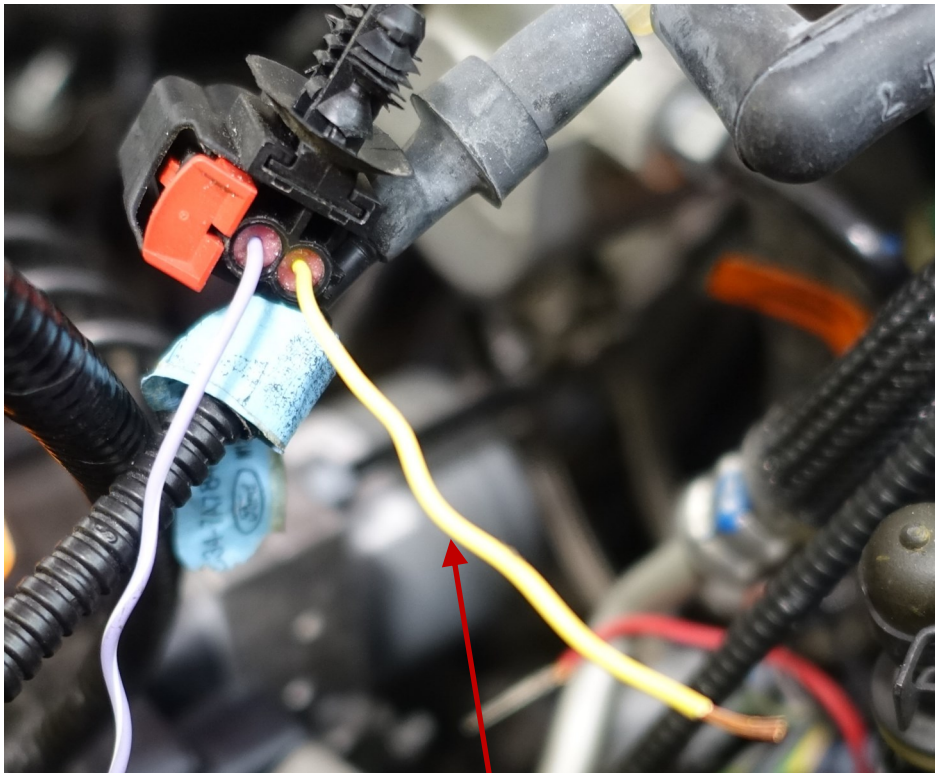

The pigtail attached to the two wire connector needs to be lengthen. Using the 20AWG yellow wire supplied, solder to the pigtail and heat shrink.

Twist the two wires together.

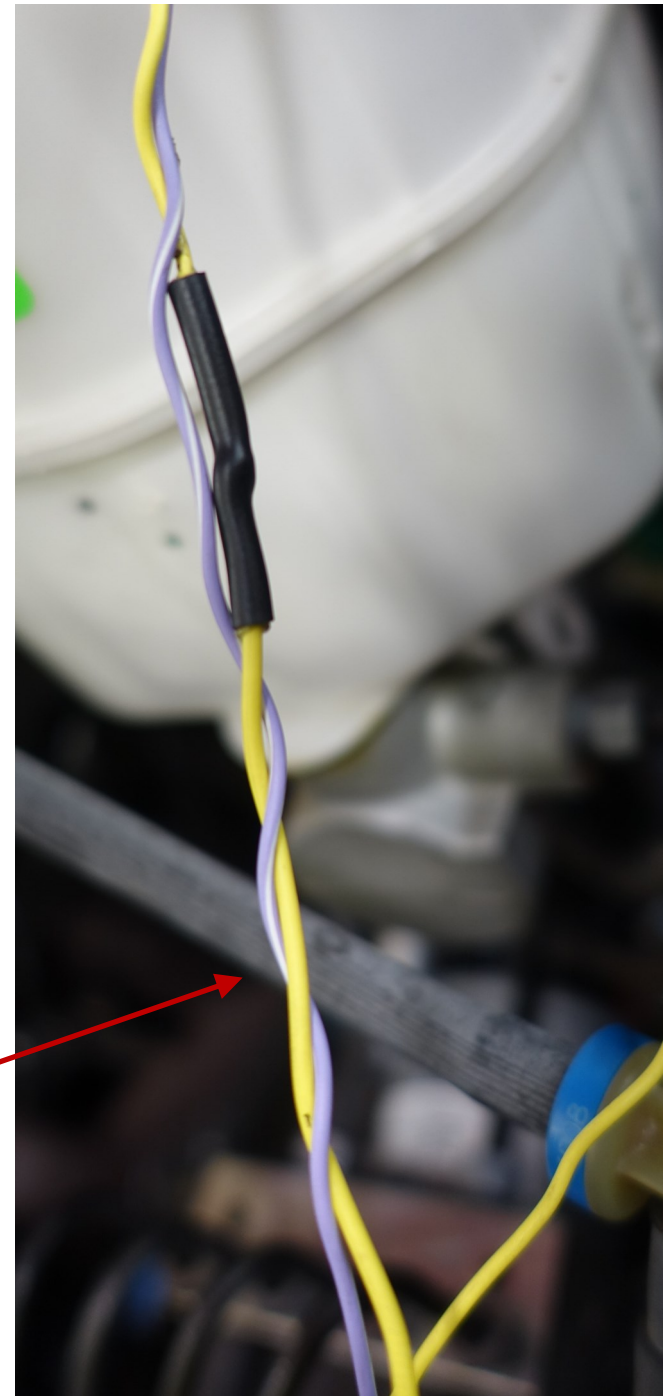

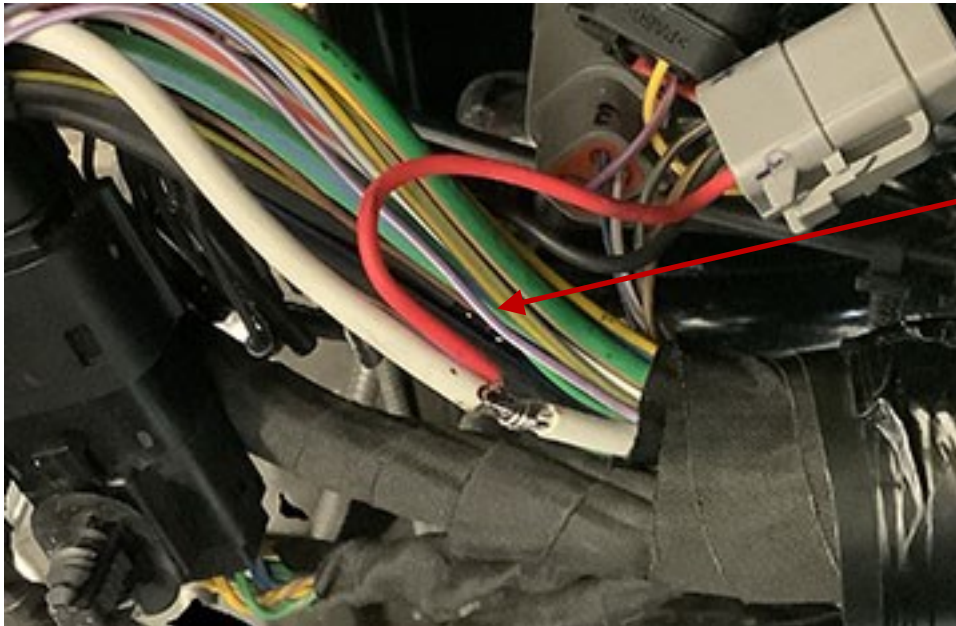

Locate the 10AWG white battery power wire and strip about 3/8" of insulation off the wire.

Solder the included red 18AWG wire to the white wire and tape well with good quality electrical tape.

Locate the 10AWG black/yellow GND wire and strip about 3/8" of insulation off it. Solder the included black 18AWG wire to the black/yellow wire and tape well with good quality electrical tape.

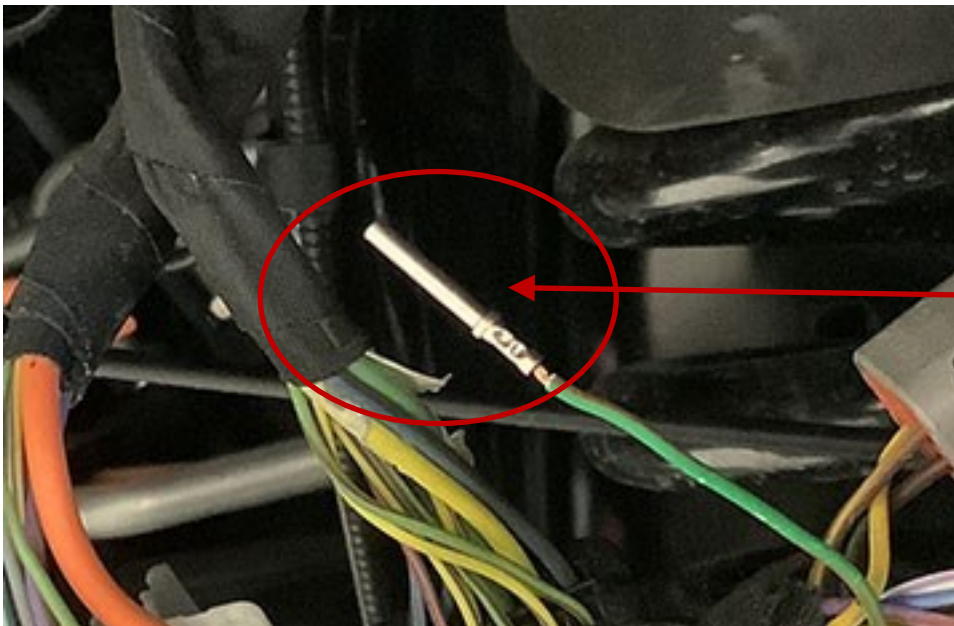

Install a Deutsch 0462-201-20141 pin on each end of the cut wires.

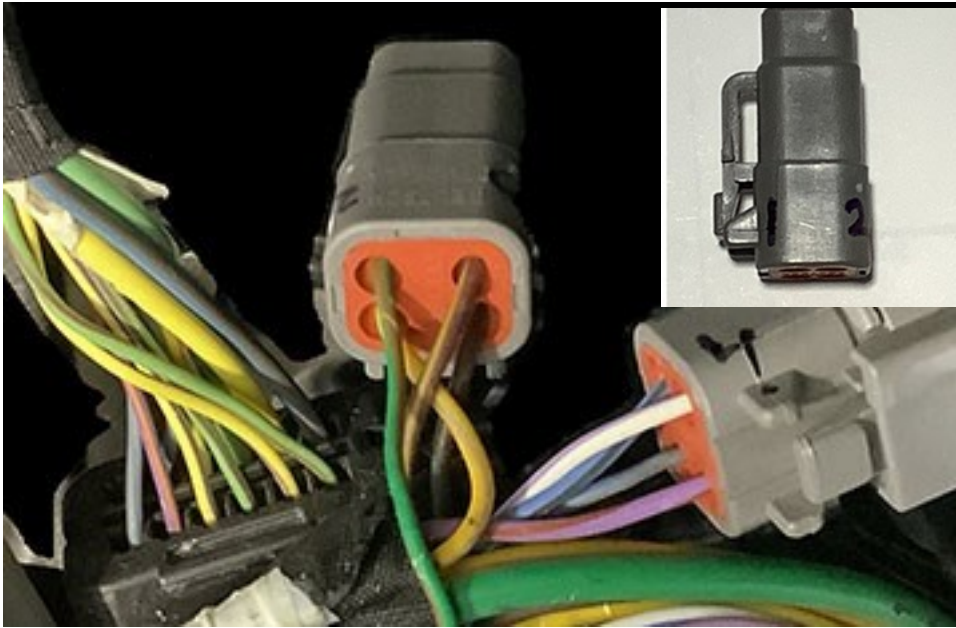

The four cut wires on the ABS connector side are inserted into the Deutsch DTM06-4S in the order shown below.

You will find it helpful to number the connector.

2023+ Pickup Truck

Yellow/Grey	Pin 1
Green/Orange	Pin 2
Brown	Pin 3
Brown/Blue	Pin 4

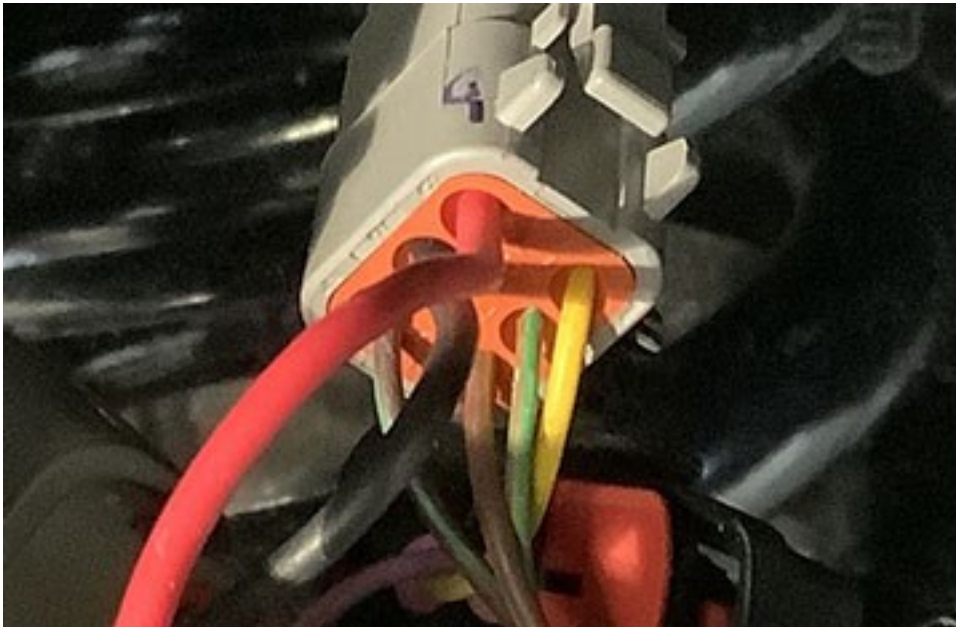

The four cut wires on the chassis side of the harness and the power and ground insert into the Deutsch DTM06-6S connector in the order shown below.

2023+ Pickup Truck

Yellow/Grey	Pin 1
Green /Orange	Pin 2
Brown	Pin 3
Brown/Blue	Pin 4
Black	Pin 5
Red	Pin 6



Install locks in both Deutsch connectors



Using the electrical tape removed, retape the harness, leaving the two Deutsch connectors and the wheel sensor connector exposed.



Reinstall the ABS connector as far as it will go, pull the gray lever down. As the lever is pulled down the connector should pull into the ABS module. Pull the lever down until latches. Slide the red lock down.

Connect the left front wheel speed sensor.

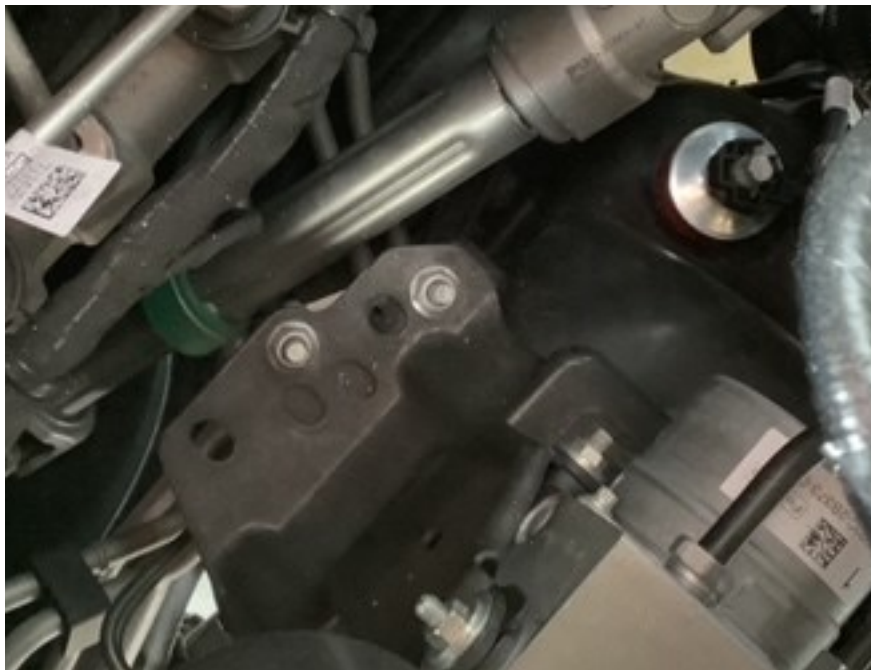

Install Mounting Bracket and Module

From inside the engine compartment locate the ABS mounting bracket retaining nuts and remove .

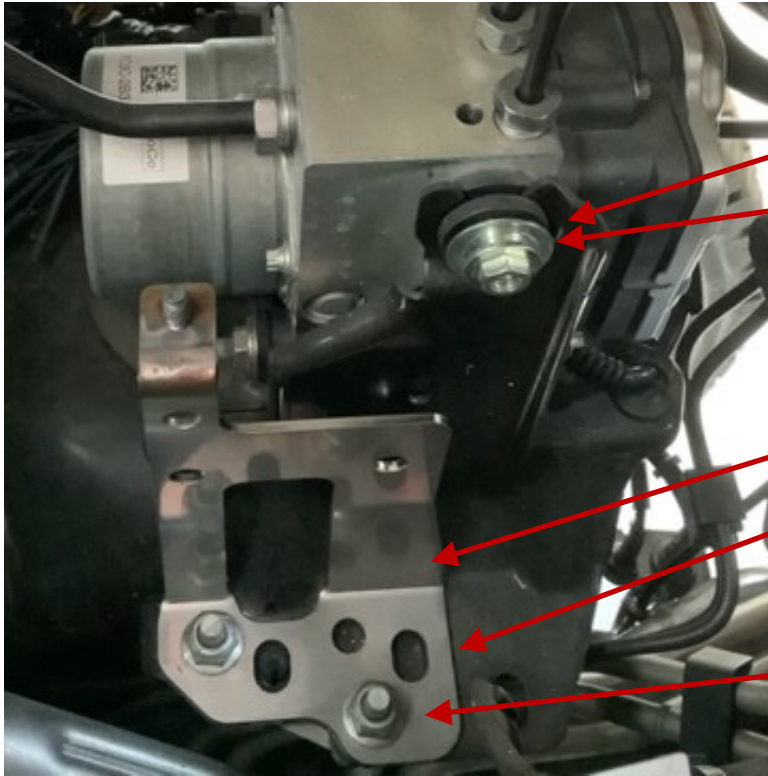

Remove Mounting Nut.

Discard Washer

Install Lower Mounting Bracket

Align mounting bracket with ABS mounting bracket

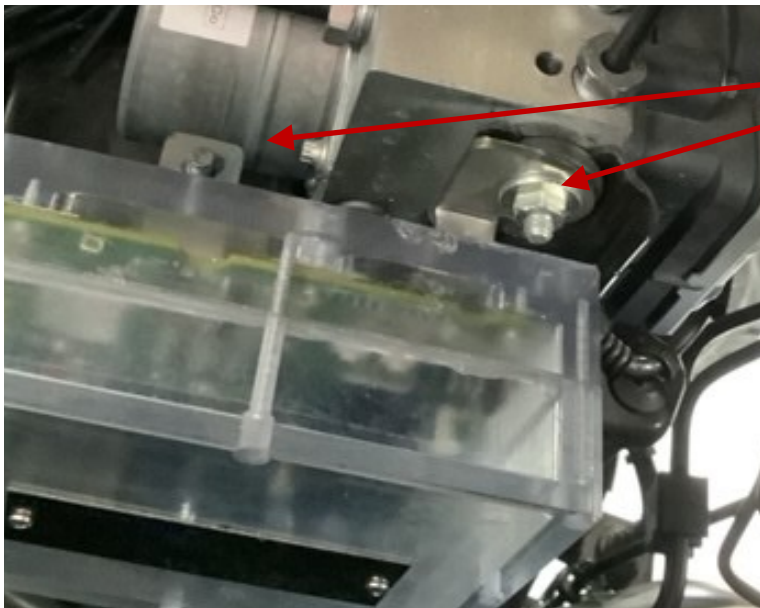

Install module on lower mounting bracket and
ABS mounting stud.

Install nuts and tighten snug.



Connect the Tru-Speed to the two Deutsch connectors.

Reconnect Battery Cables

At this point, taking the truck on a short test drive on dry roads is advisable to confirm proper installation. Use a GPS to confirm the correct calibration.

If an error or warning appears in the cluster, see Appendix A at the rear of this installation manual.

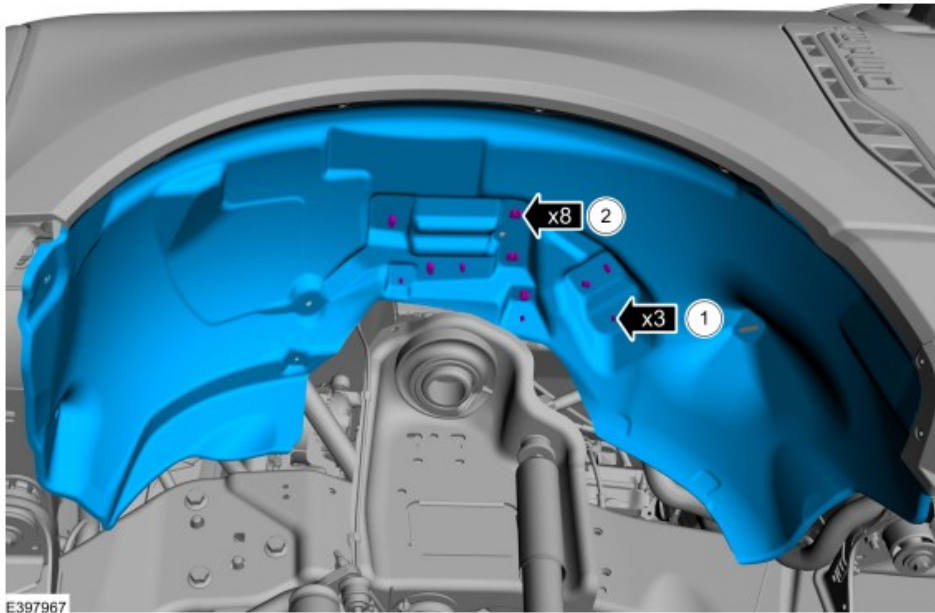

1. Reinstall the wheel liner.
2. Push the hood latch release cable retainer into the liner. 3 times
3. Push the wiring harness retainers into the wheel liner. 8 times

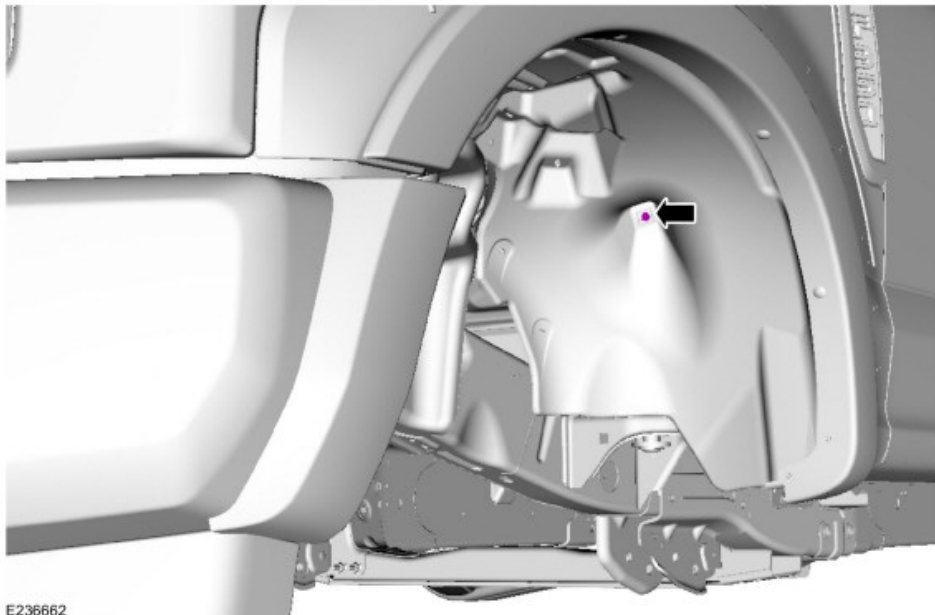

Install the nut.

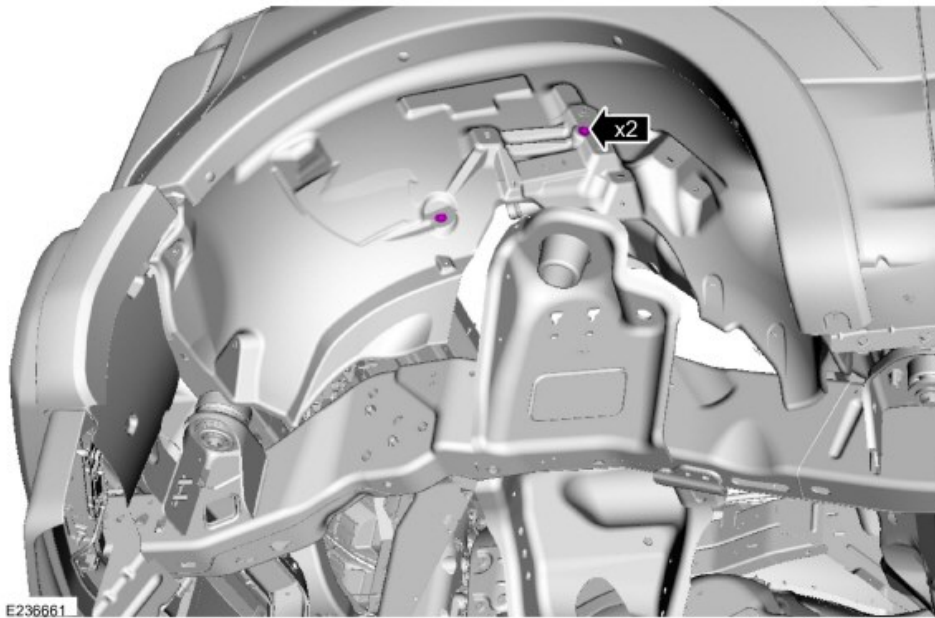

Using a 10mm socket, reinstall the two bolts.

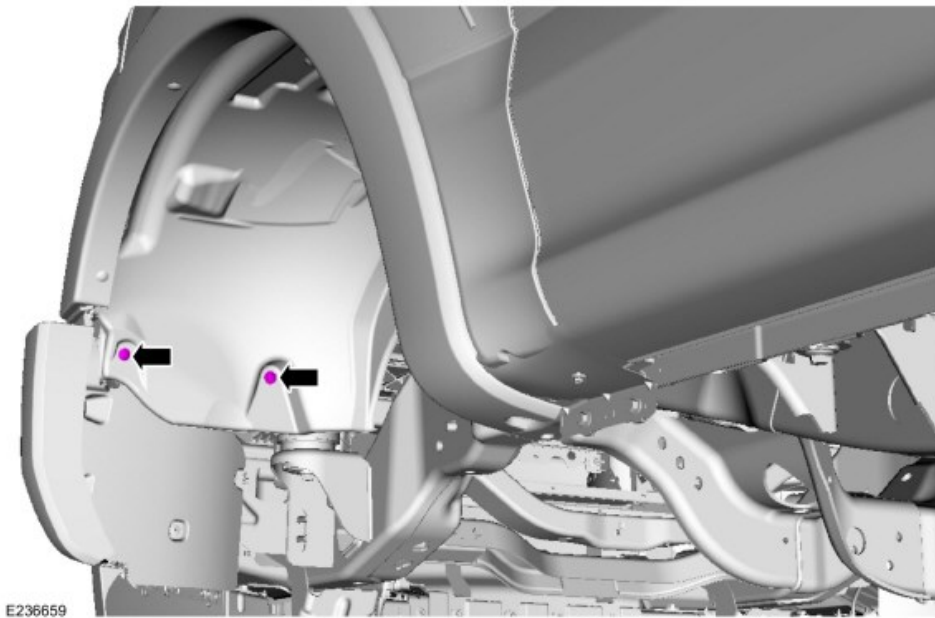

Using a 10mm socket, reinstall the bolt and pushpin.

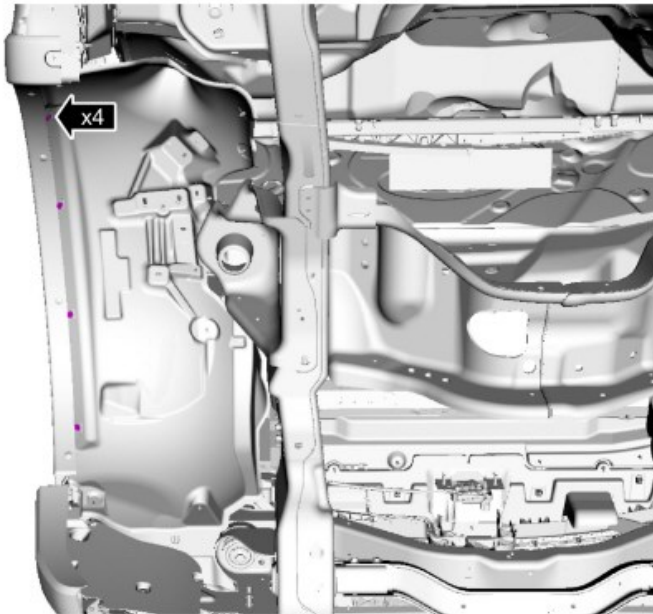

E236660

Using the 5.5mm socket, reinstall the four screws retaining the wheel liner to the fender. The screws are located just inside the wheel lip.

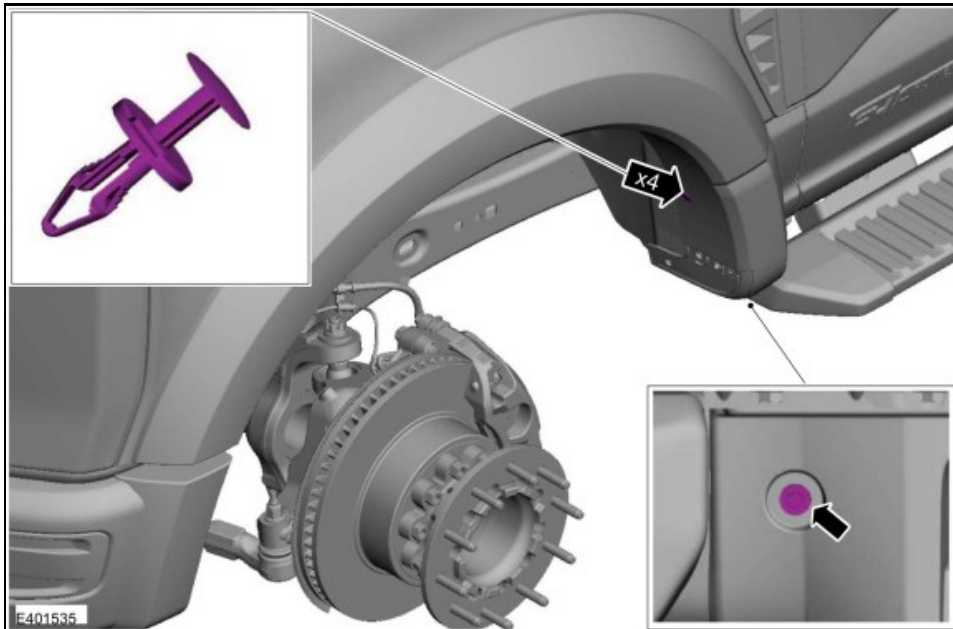

E401585

Reinstall the four pushpins and the retainers attaching wheel lip to the fender.

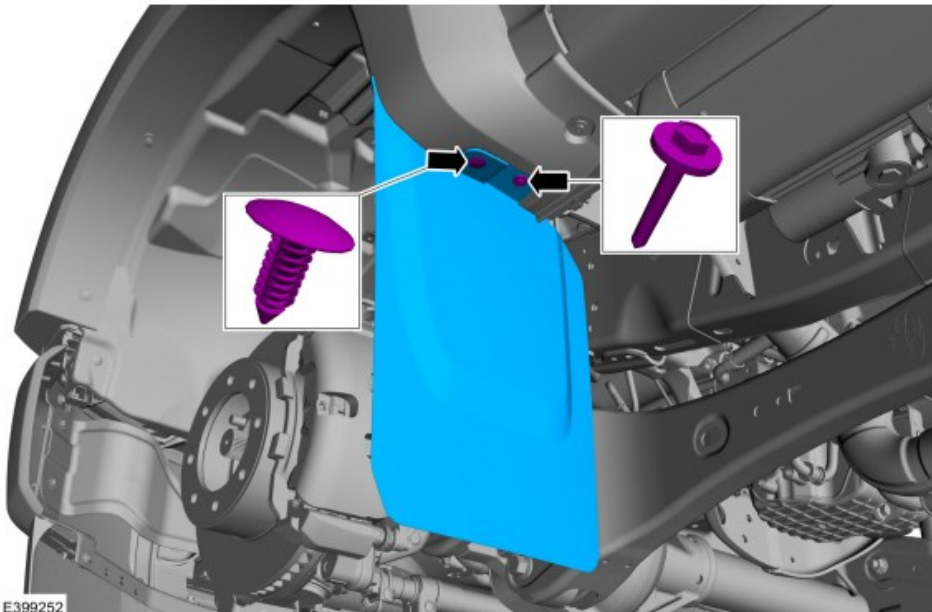

If equipped with mudflaps,
reinstall the mud flap pushpin and bolt.

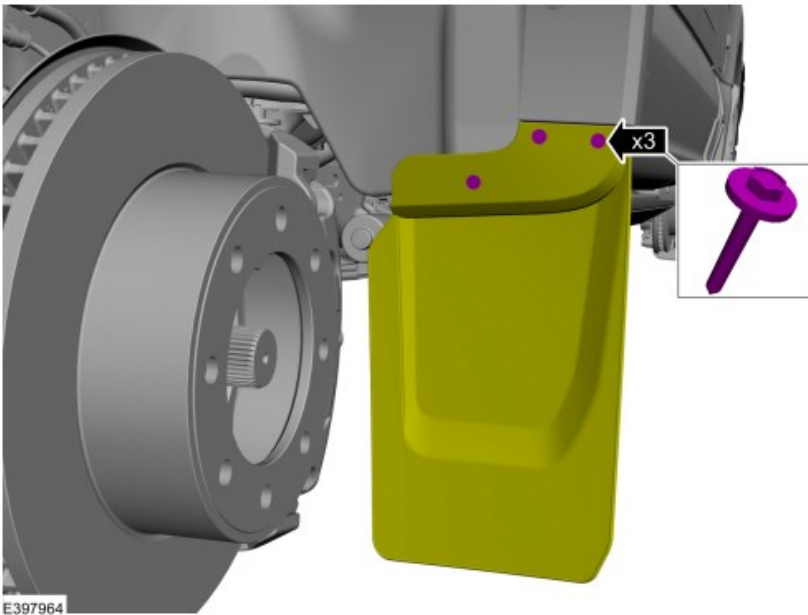

If equipped with mud flaps,
use a 7mm wrench to
reinstall the three bolts.

Appendix A

Error codes displayed in the instrument cluster can be caused when the ABS connector is disconnected; however, they should clear when the Tru-Speed is connected.

If the errors persist, check the following.

- Confirm locks are installed in Deutsch connectors
- Confirm that the wires are inserted in the connector in the proper order.
- Confirm wires are inserted fully into the Deutsch connectors.
- Disconnect batteries and reconnect.

For additional technical help, call or email.

DirectDrive Plus LLC

Phone : 610-273-2071

Email Info@directdriveplus.com

