

FIRE DEPARTMENT APPROVAL		DATE	BY	DESCRIPTION	REV	DATE	BY	DESCRIPTION
		03-24-2022			B			

REV	DATE	BY	DESCRIPTION
B	03-24-2022		

REV	DATE	BY	DESCRIPTION
D			

REV	DATE	BY	DESCRIPTION
300			
750			

REV	DATE	BY	DESCRIPTION
	5/18/2020		

REV	DATE	BY	DESCRIPTION



Body Dimensions

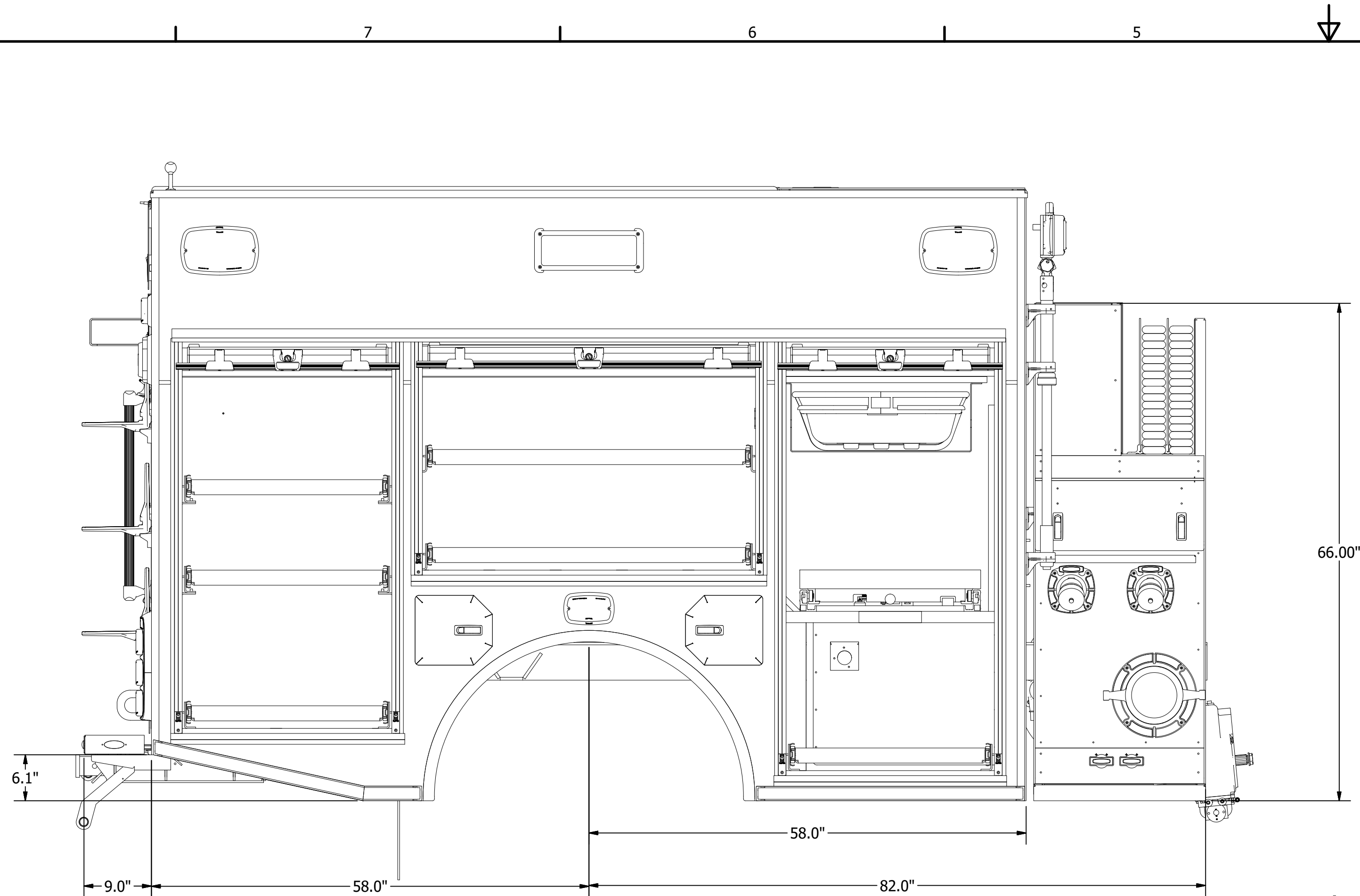

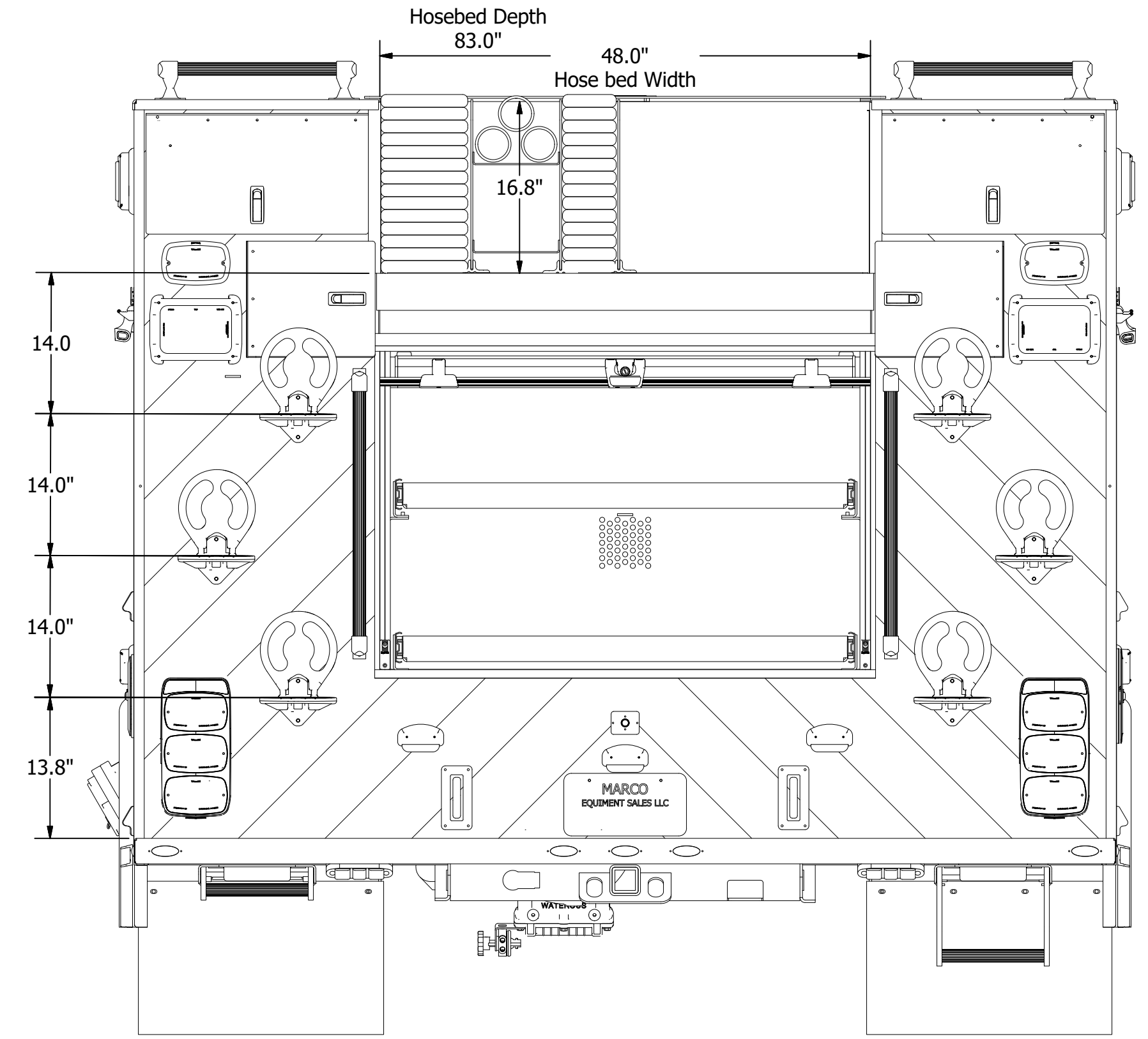
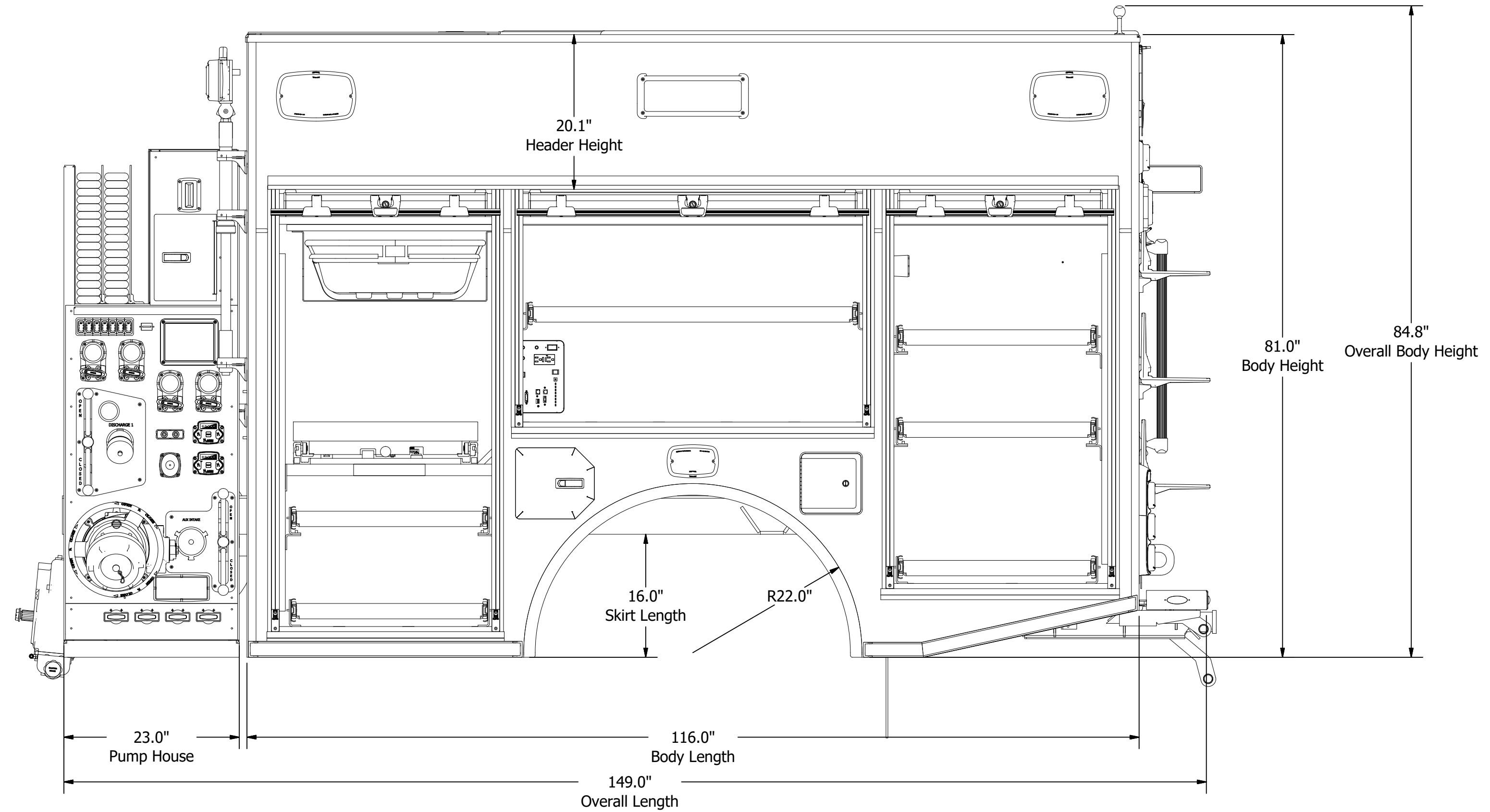
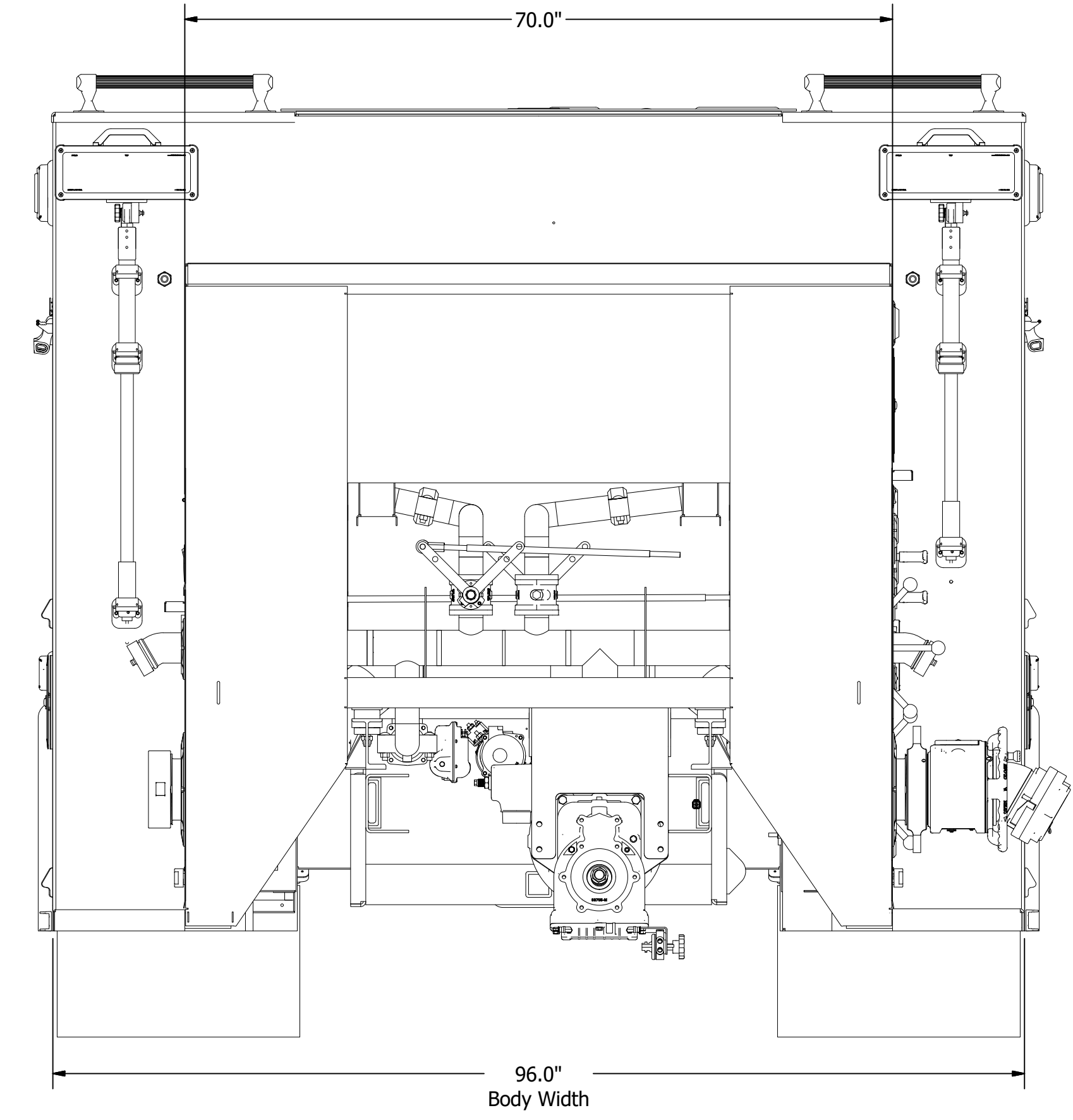
FIRE DEPARTMENT APPROVAL		DATE	BY	DESCRIPTION	REV	DATE	BY	DESCRIPTION	REV	DATE	BY	DESCRIPTION
					A	02-11-2022						
					B	03-23-2022						
					D							

FORD  
 F550  
 Attack  
 300  
 750  
 MARCO  
 EQUIPMENT SALES LLC  
 Elgin Beaverdam Fire Dept.  
 Attack  
 Elgin Beaverdam - Body Dimensions  
 SHEET 1 OF 1

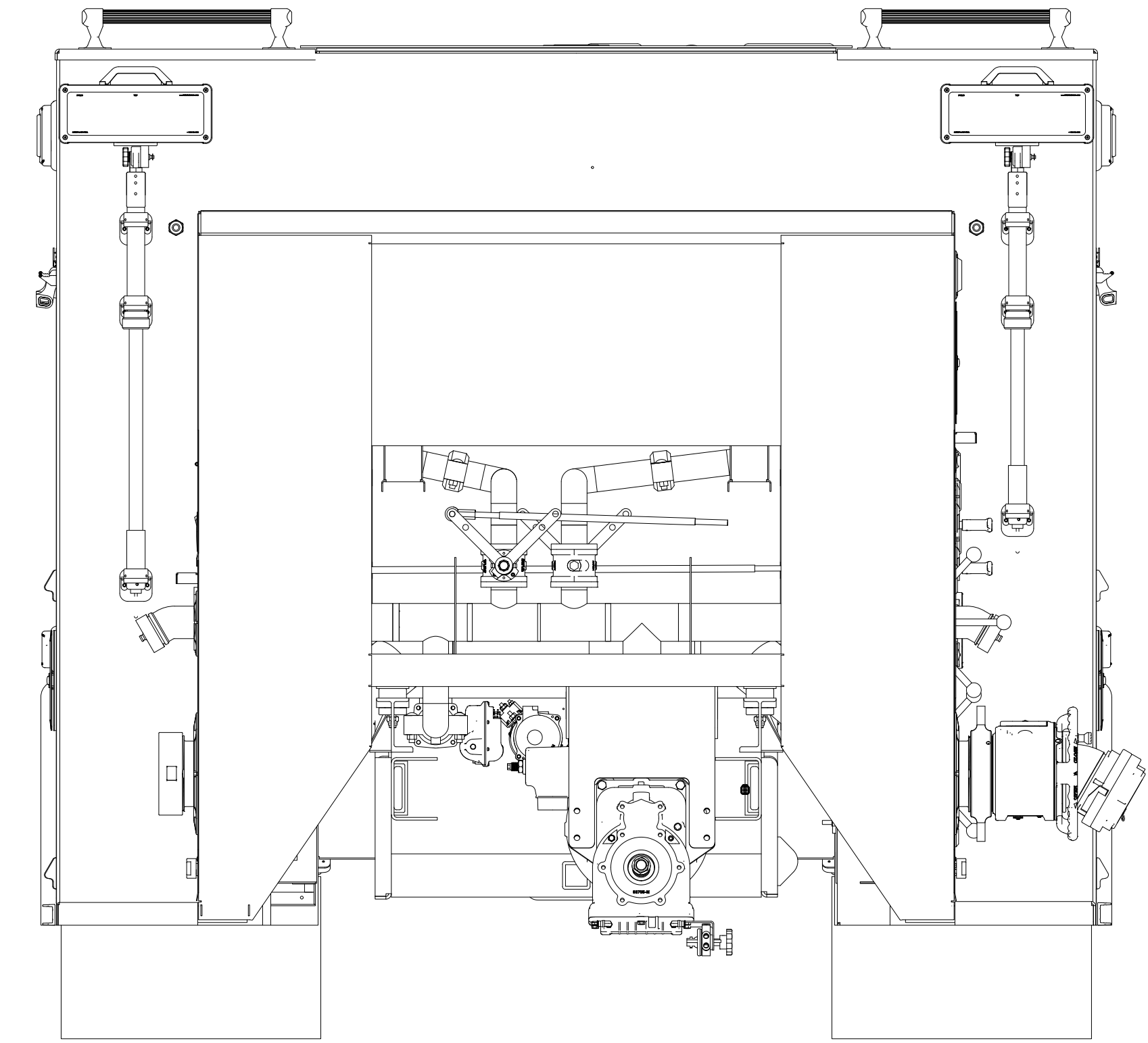
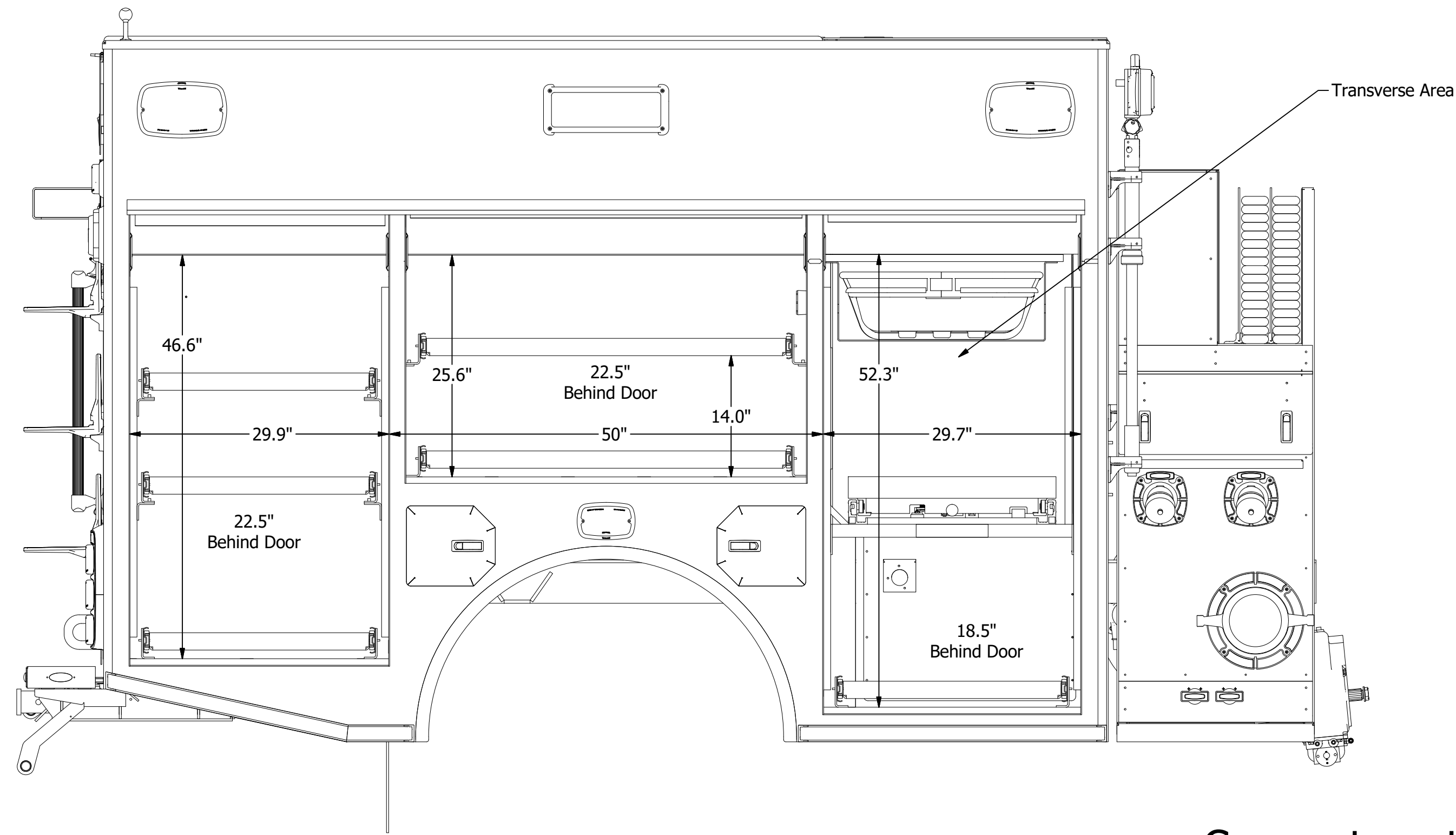

Compartment Dimensions  
Wall to Wall

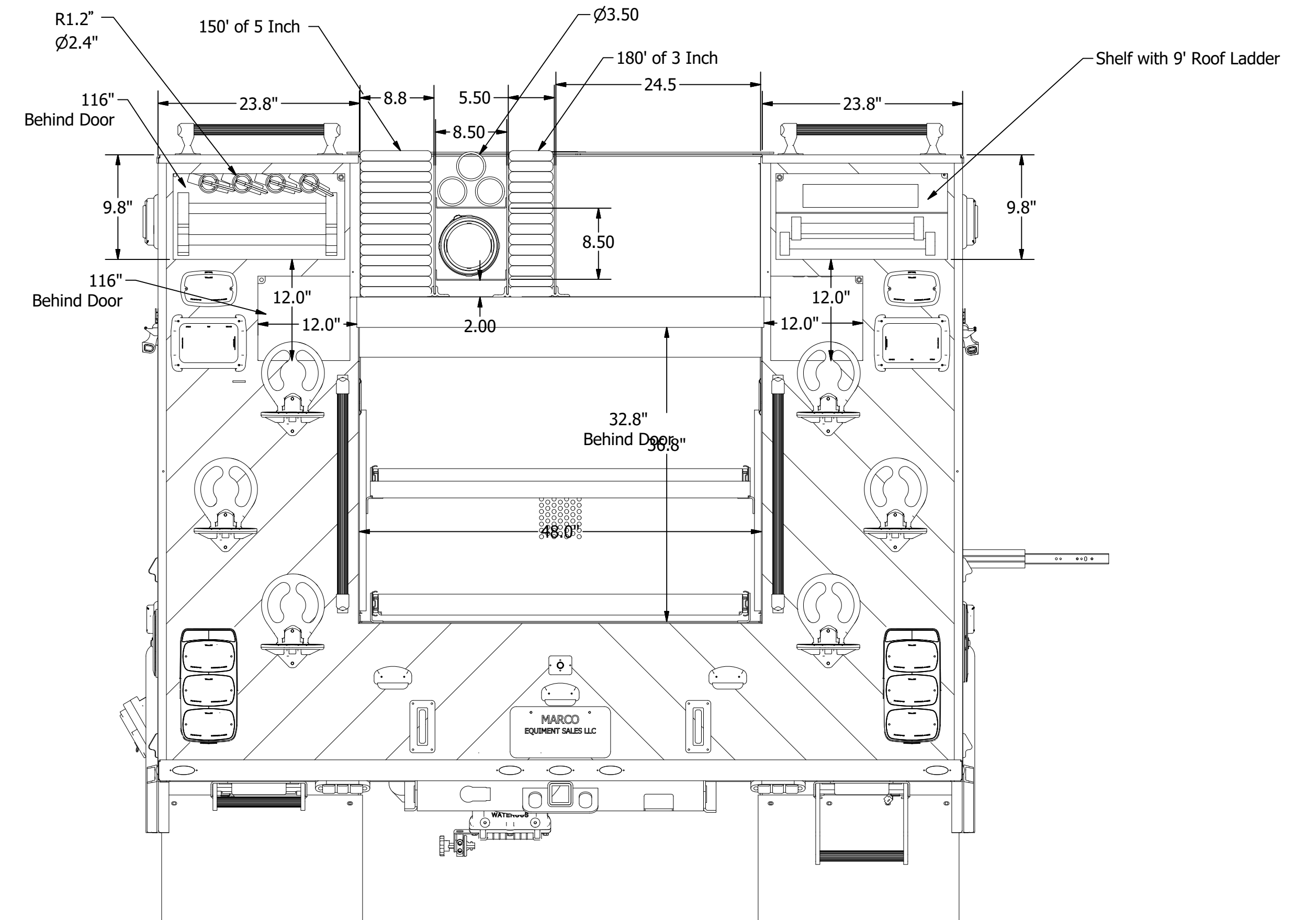
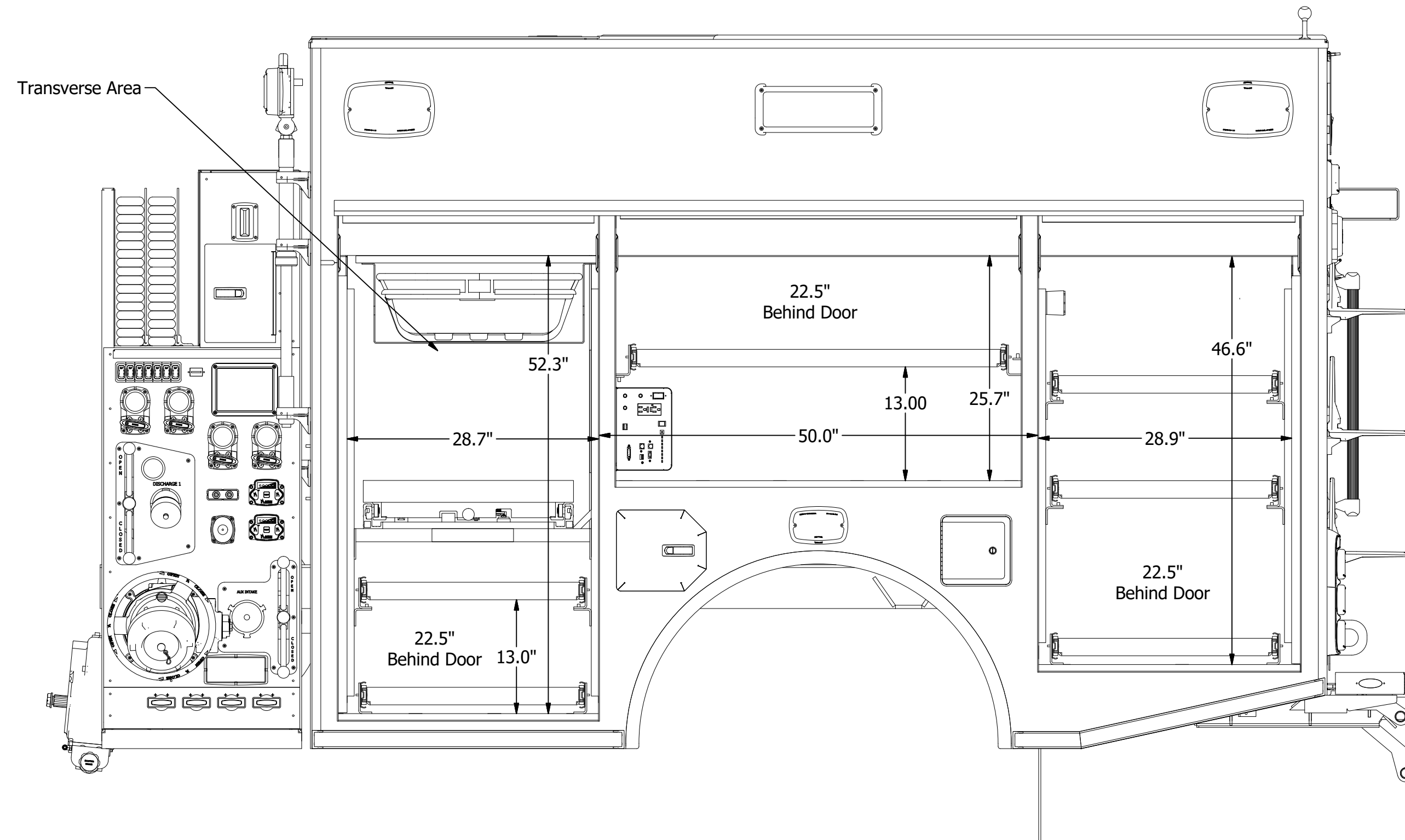

FIRE DEPARTMENT APPROVAL \_\_\_\_\_ DATE \_\_\_\_\_

REV	DATE	BY	DESCRIPTION	REV	DATE	BY	DESCRIPTION
A	02-11-2022			1	10/30/2020		
B	03-23-2022			2			

  

300	750	D	750
		D	
		D	

Elgin Beavertdam Fire Dept.  
 MARCO  
 Elgin Beavertdam - Compartment  
 SHEET 1 OF 1

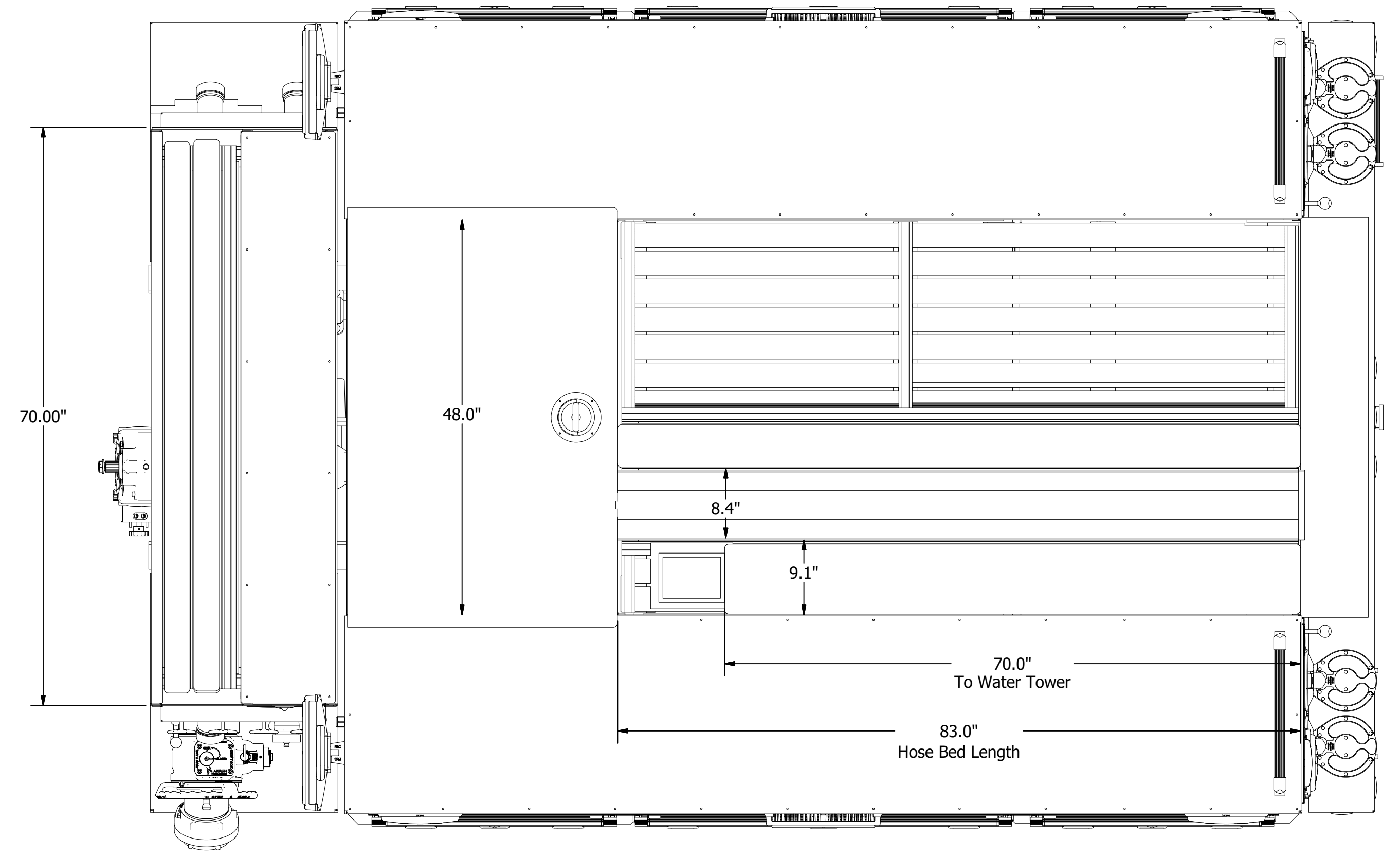
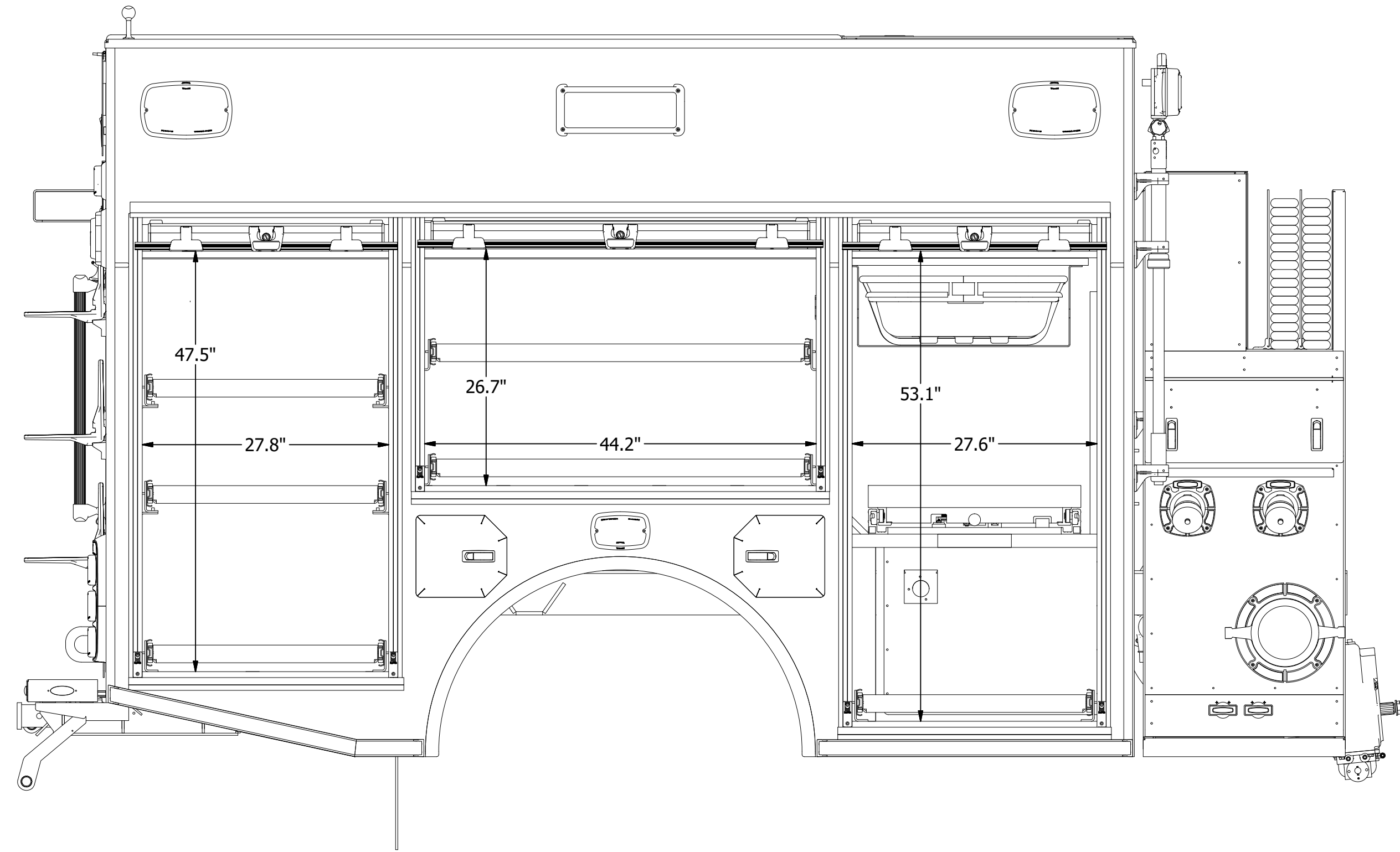

Door Opening Dimensions

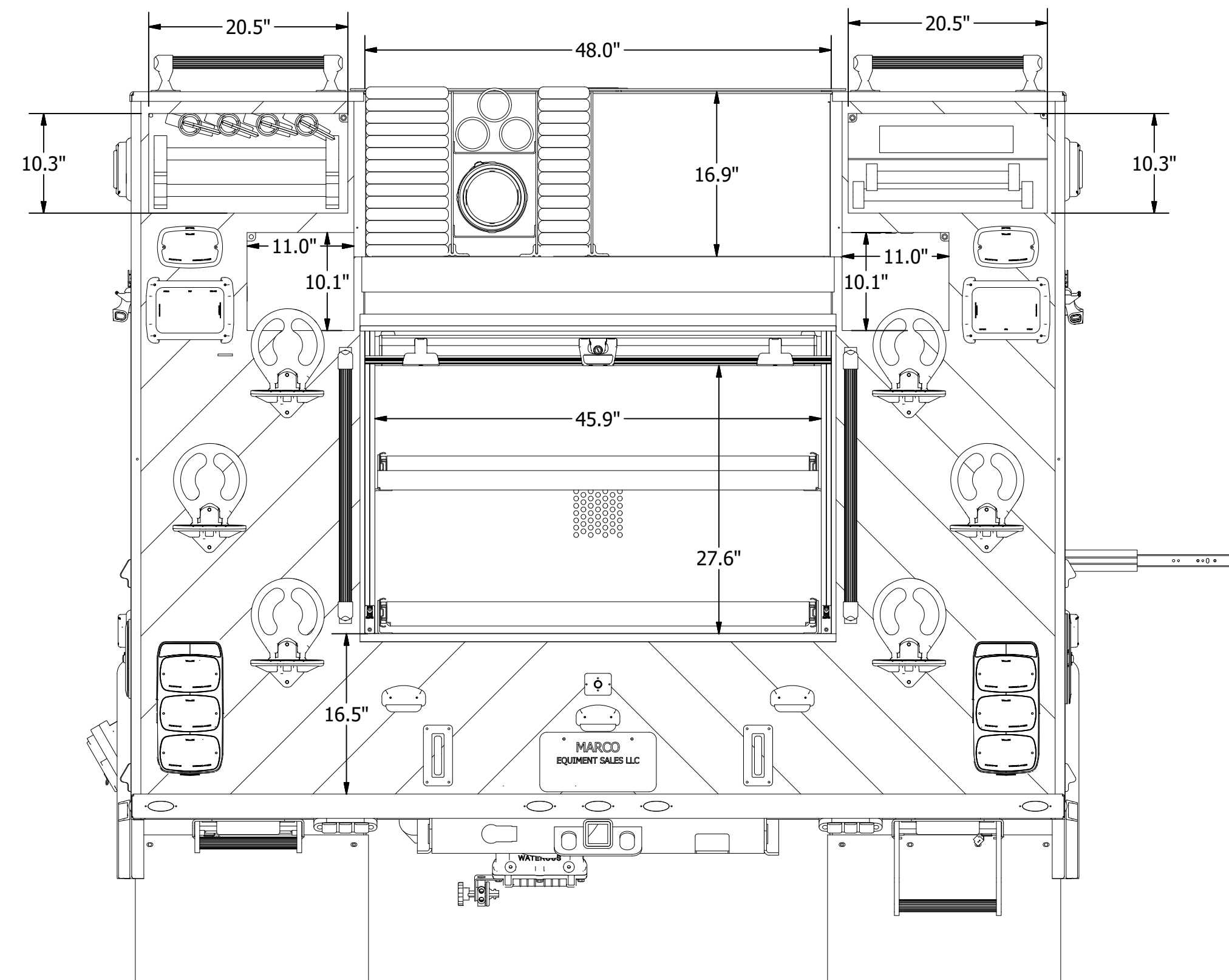
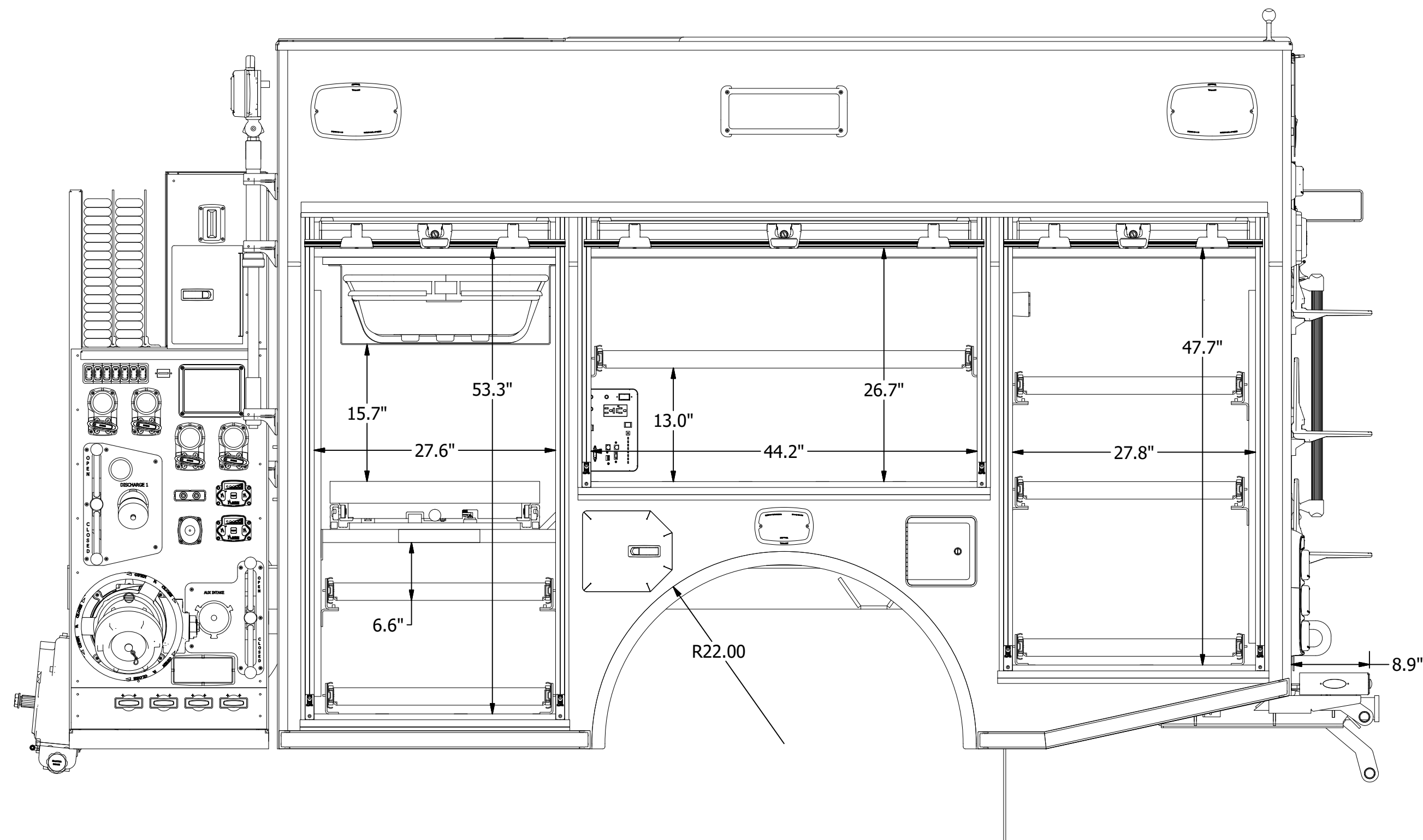

FIRE DEPARTMENT APPROVAL \_\_\_\_\_ DATE \_\_\_\_\_

REV	DATE	BY	DESCRIPTION
A	02-11-2022		
B	03-23-2022		

Customer's Name/Dept	10/30/2020	<b>MARCO</b>	Part Number/Rev	
Model	FORD		Part Name	Elgin Beaverdam Fire Dept. Attack
Options	F550		Size	D
Quantity	300		Scale	1/8" = 1'-0"
Part No.	750		Drawn By	Elgin Beaverdam - Door Opening Dimensions
<small>Elgin Beaverdam Sales, LLC RESERVES THE RIGHT TO MAKE PRICE CORRECTIONS, CHANGES AND OMISSIONS WITHOUT NOTICE FOR PRODUCT DEVELOPMENT.</small>		<small>© 2020 MARCO EQUIPMENT SALES, LLC</small>		

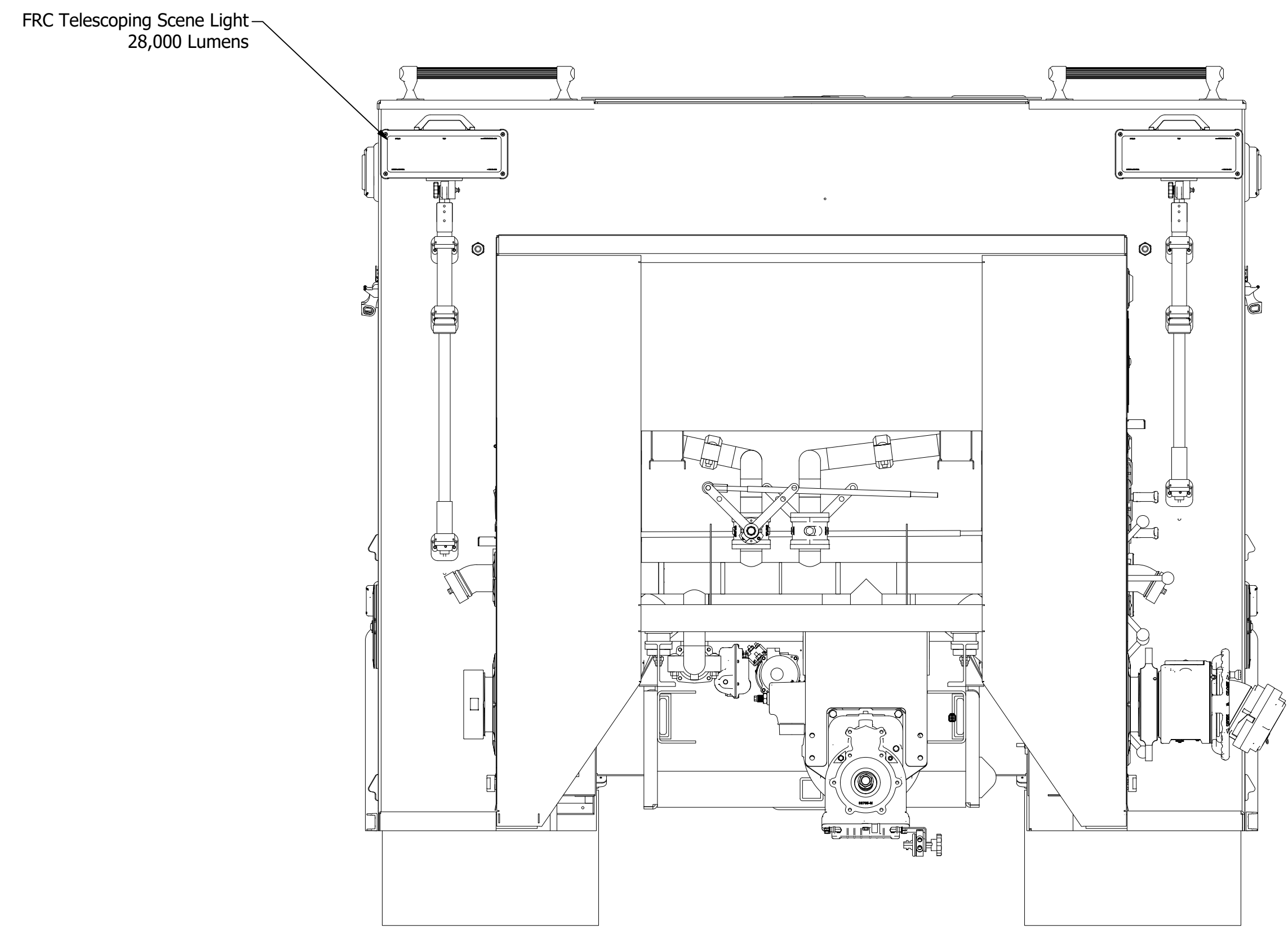
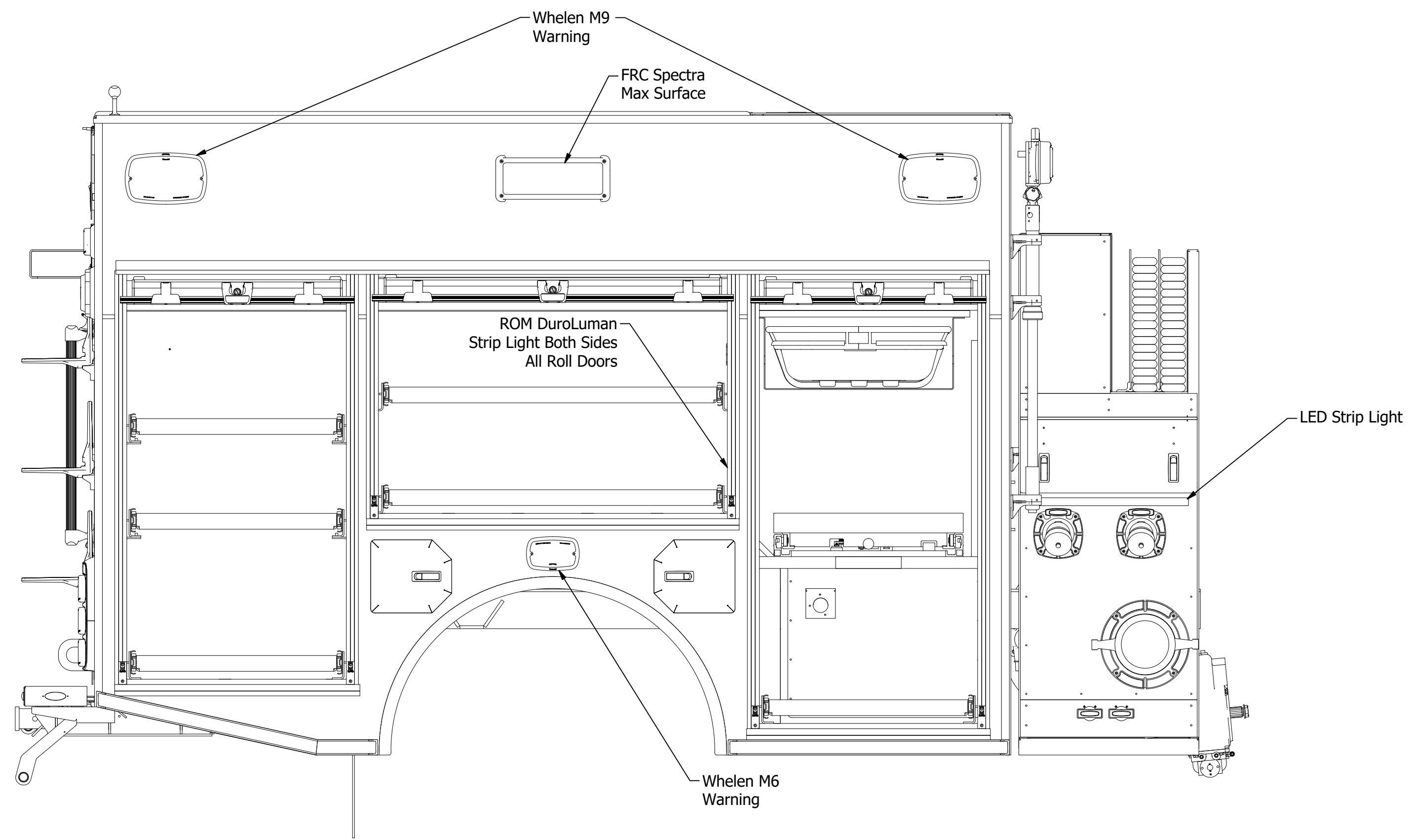

Lighting

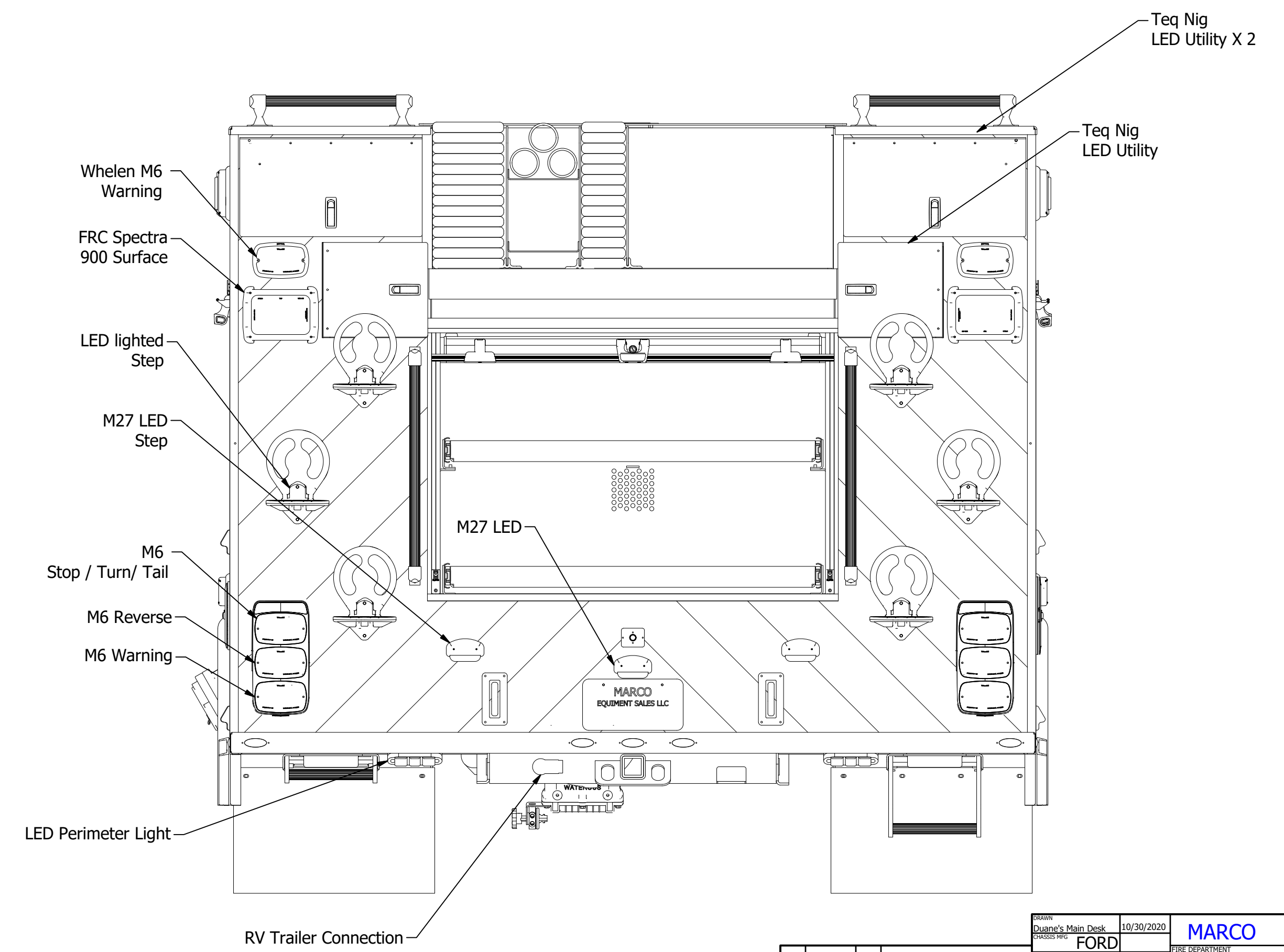
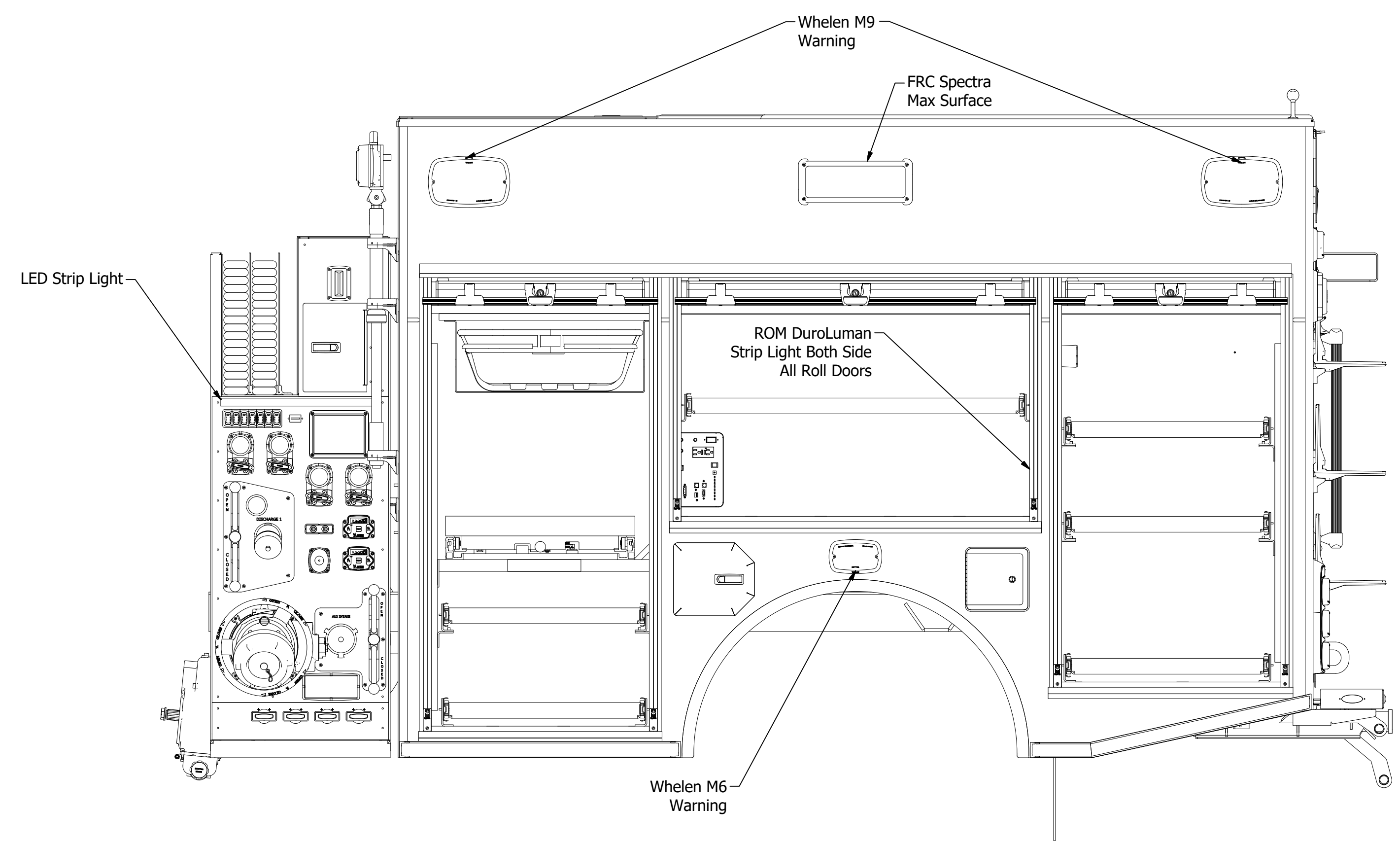

FIRE DEPARTMENT APPROVAL \_\_\_\_\_ DATE \_\_\_\_\_

REV	DATE	BY	DESCRIPTION	REV	DATE	BY	DESCRIPTION
A	02-11-2022			FORD	10/30/2020		MARCO
B	03-23-2022			F550			Elgin Beaverdam Fire Dept.
				Attack			Attack
				300			
				750			
				D			Elgin Beaverdam - Lighting
				D			Elgin Beaverdam - Lighting

8 7 6 5 4 3 2 1

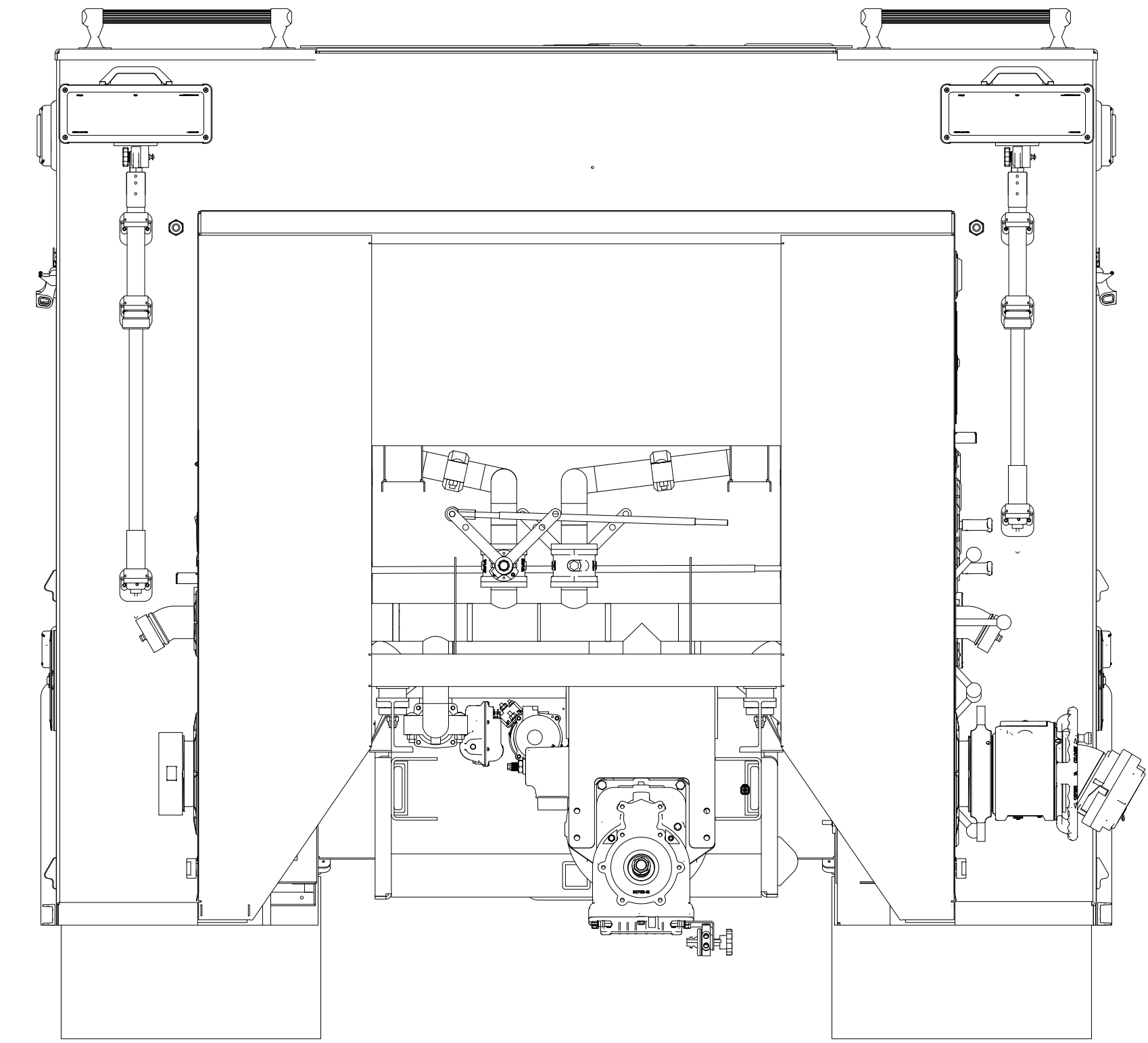
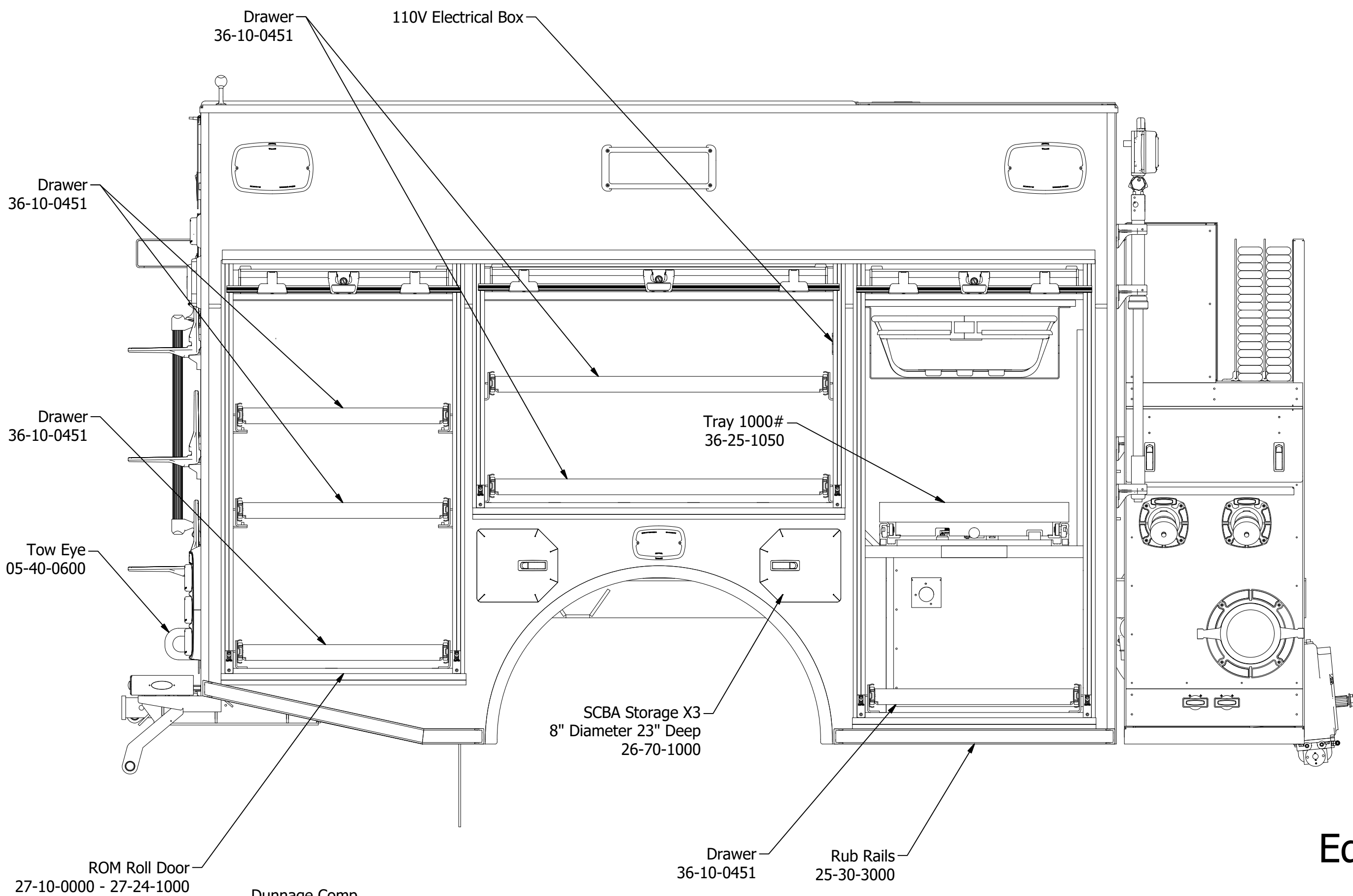

**Equipment**

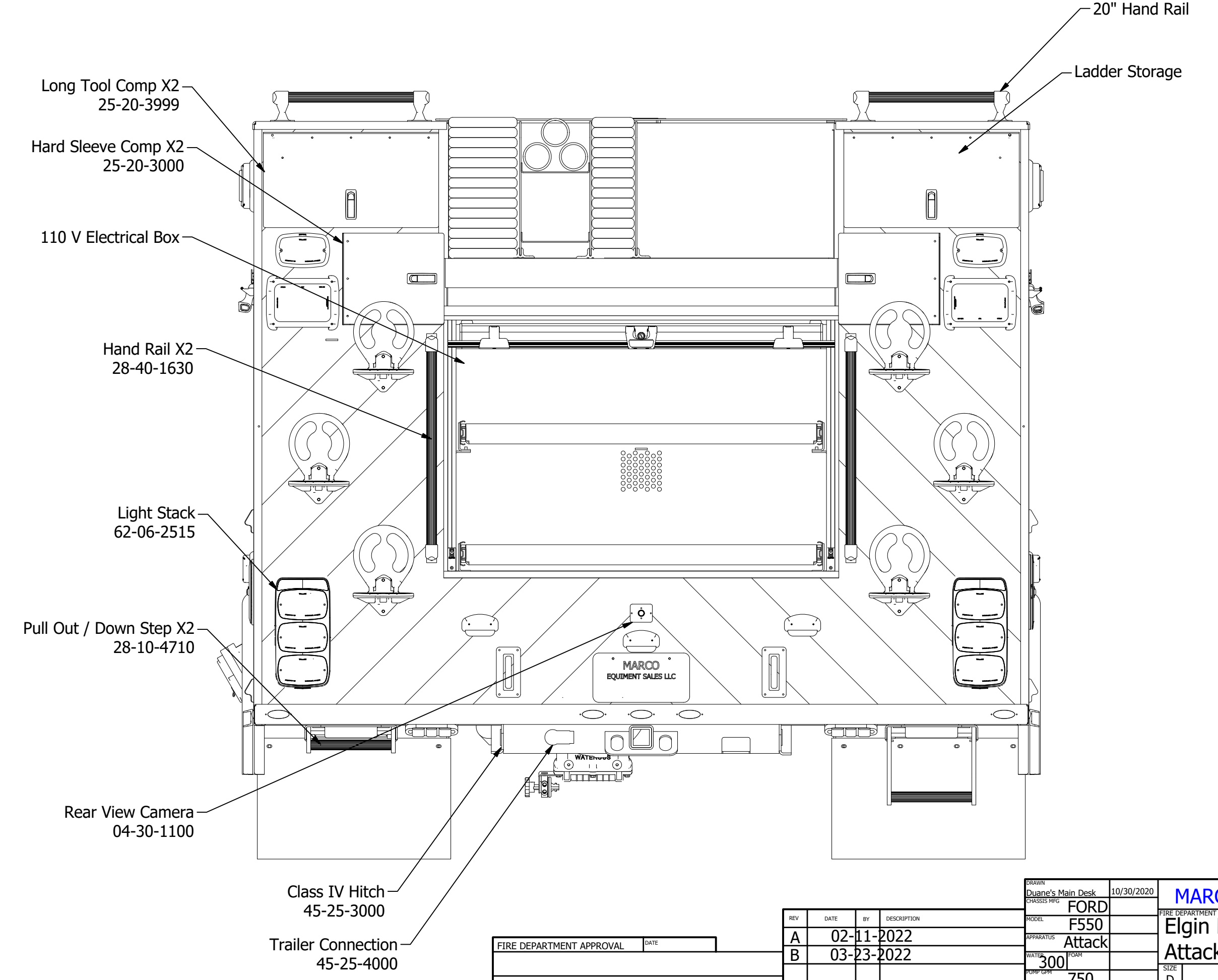
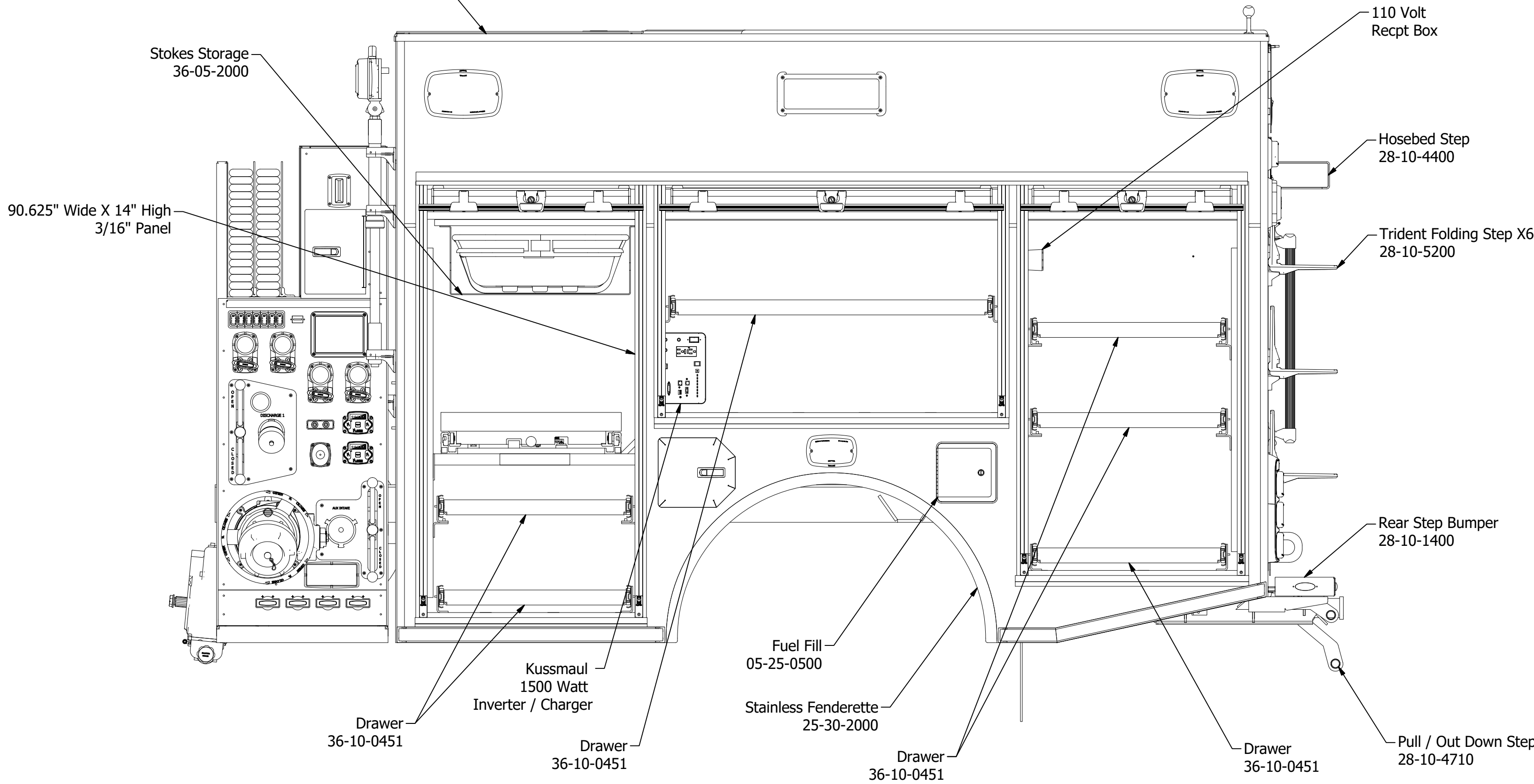

FIRE DEPARTMENT APPROVAL \_\_\_\_\_ DATE \_\_\_\_\_

REV	DATE	BY	DESCRIPTION
A	02-11-2022		
B	03-23-2022		

Equipment's Make, Model, Stock #, Date, and Price  
**MARCO**  
 Equipment Sales LLC  
 117 Franklin Ave. #204  
 Elgin, IL 60120  
 (815) 231-9977 Fax: (815) 231-9989

Make	FORD	Model	F550
Year	2022	Options	Attack
Price	300	Weight	750
Size	D	Draw No	Elgin Beaverdam - Equipment
Scale		Sheet	1 OF 1

8 7 6 5 4 3 2 1

# Pump House Dimensions

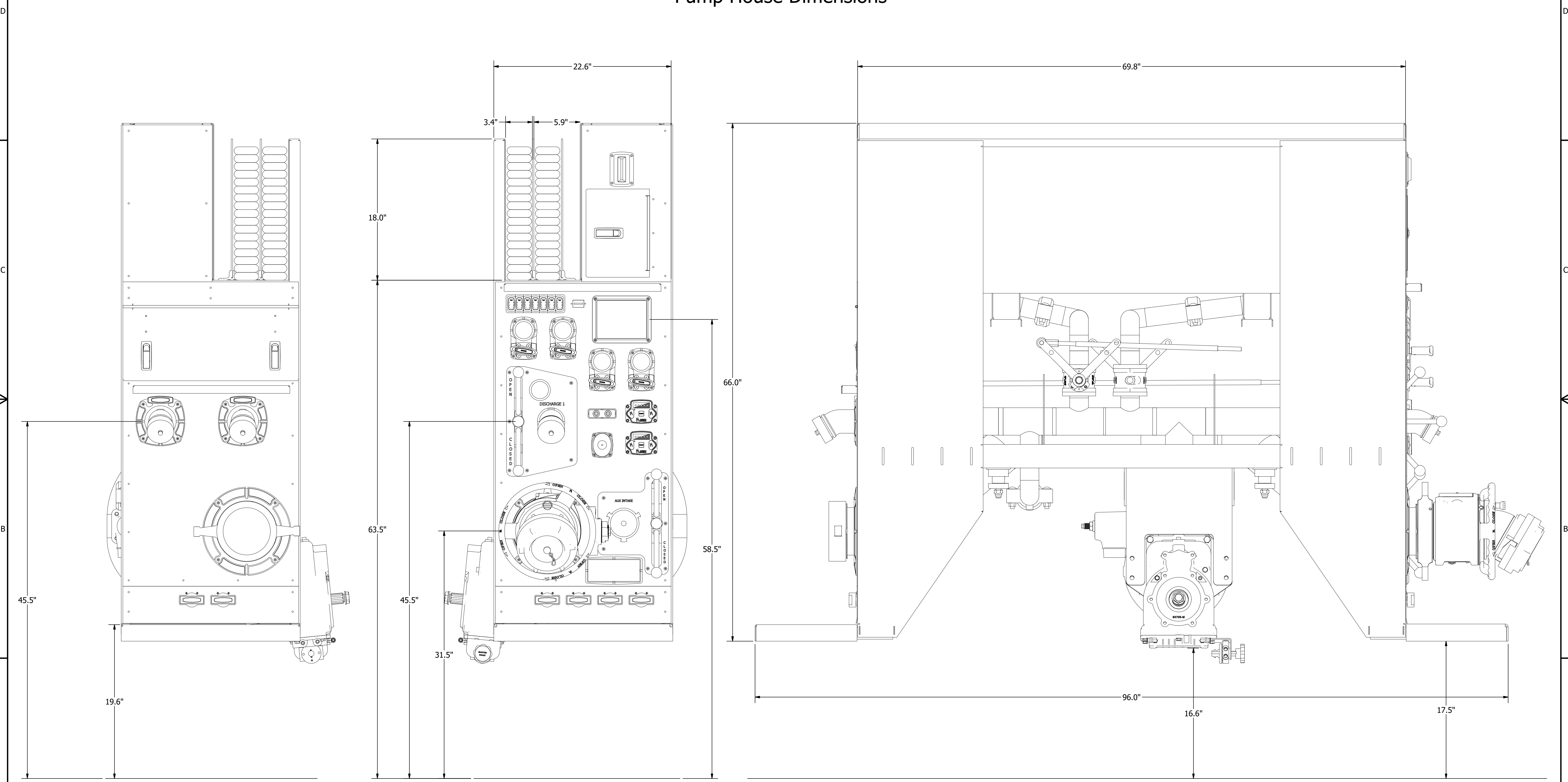

## Ground Plane

FIRE DEPARTMENT APPROVAL		DATE	BY	DESCRIPTION	REV	DATE	BY	DESCRIPTION
					B	03-23-2022		
					D			

Project Name	Elgin's Main Deck	Date	12/10/2020
Project No.	F550	Client	MARCO
Project Status	Attack	Project Manager	Elgin Beaverdam Fire Dept.
Project Size	300	Project No.	Attack
Project Scale	750	Project No.	Elgin Beaverdam - Pump House
		Project No.	Attack
		Project No.	Elgin Beaverdam - Pump House

# Pump Panel

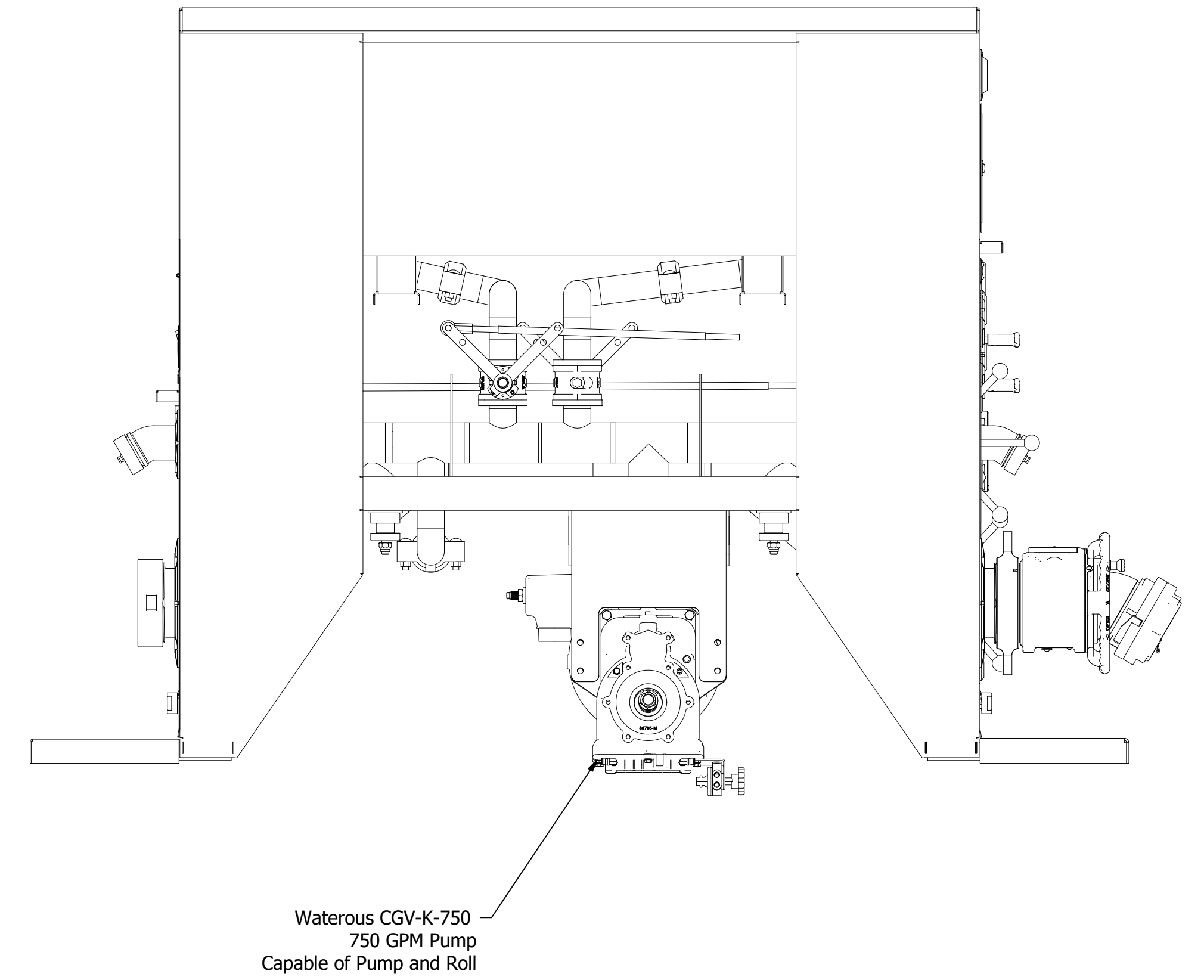
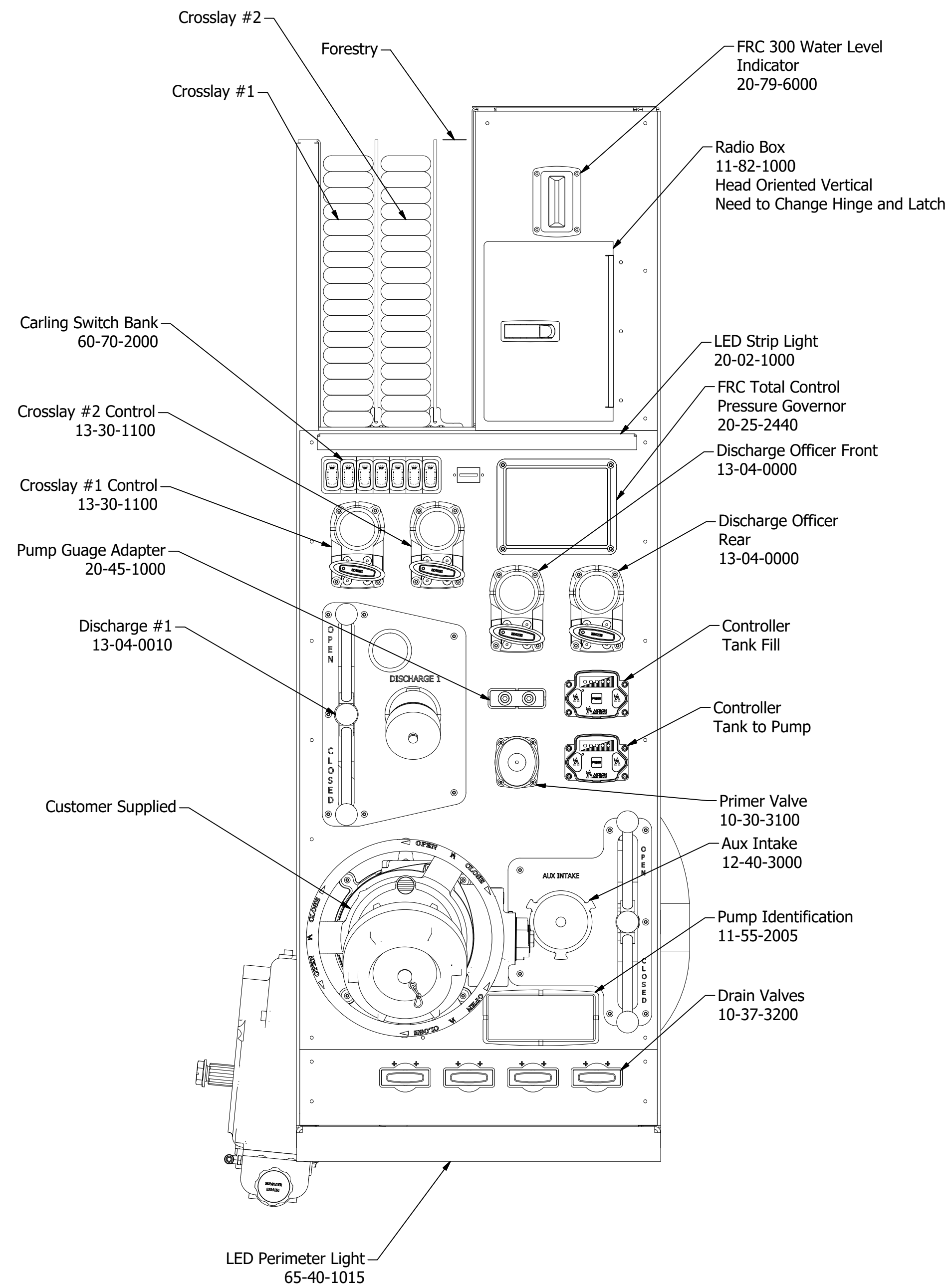
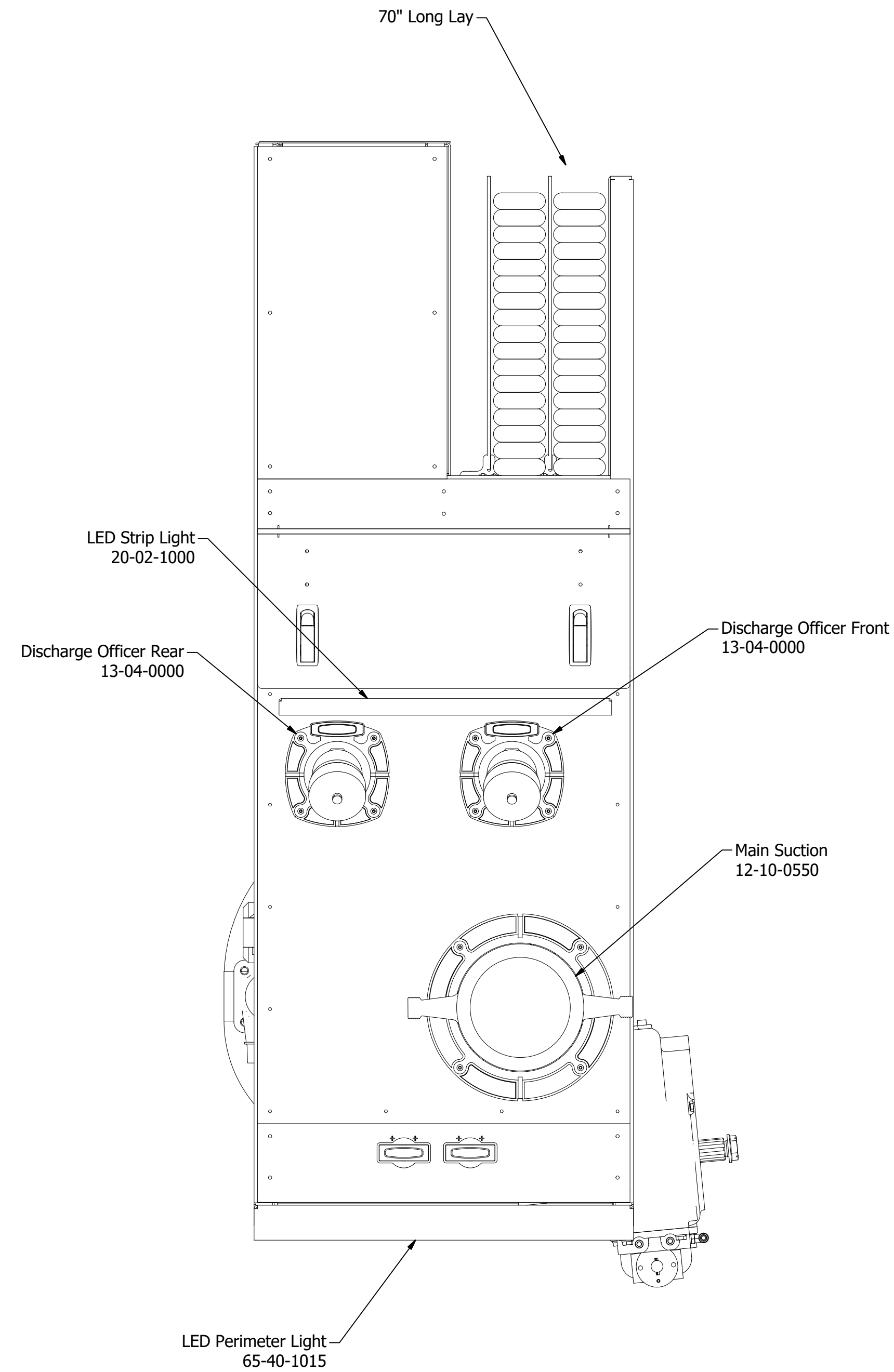

FIRE DEPARTMENT APPROVAL		DATE	BY	DESCRIPTION	REV	DATE	BY	DESCRIPTION
					A	02-11-2022		
					B	03-23-2022		

  

REV	DATE	BY	DESCRIPTION	REV	DATE	BY	DESCRIPTION
A	02-11-2022			FORD	12/10/2020		
B	03-23-2022			F550			
				Attack			
				300			
				750			

PROJECT	Elgin Beaverdam Fire Dept.	DATE	12/10/2020
DRAWN BY	MARCO	CHECKED BY	
PROJECT NO.		DATE	
PROJECT NAME	Elgin Beaverdam Fire Dept.	PROJECT NO.	
PROJECT ADDRESS	Attack	PROJECT NO.	
PROJECT CITY		PROJECT NO.	
PROJECT STATE		PROJECT NO.	
PROJECT ZIP		PROJECT NO.	



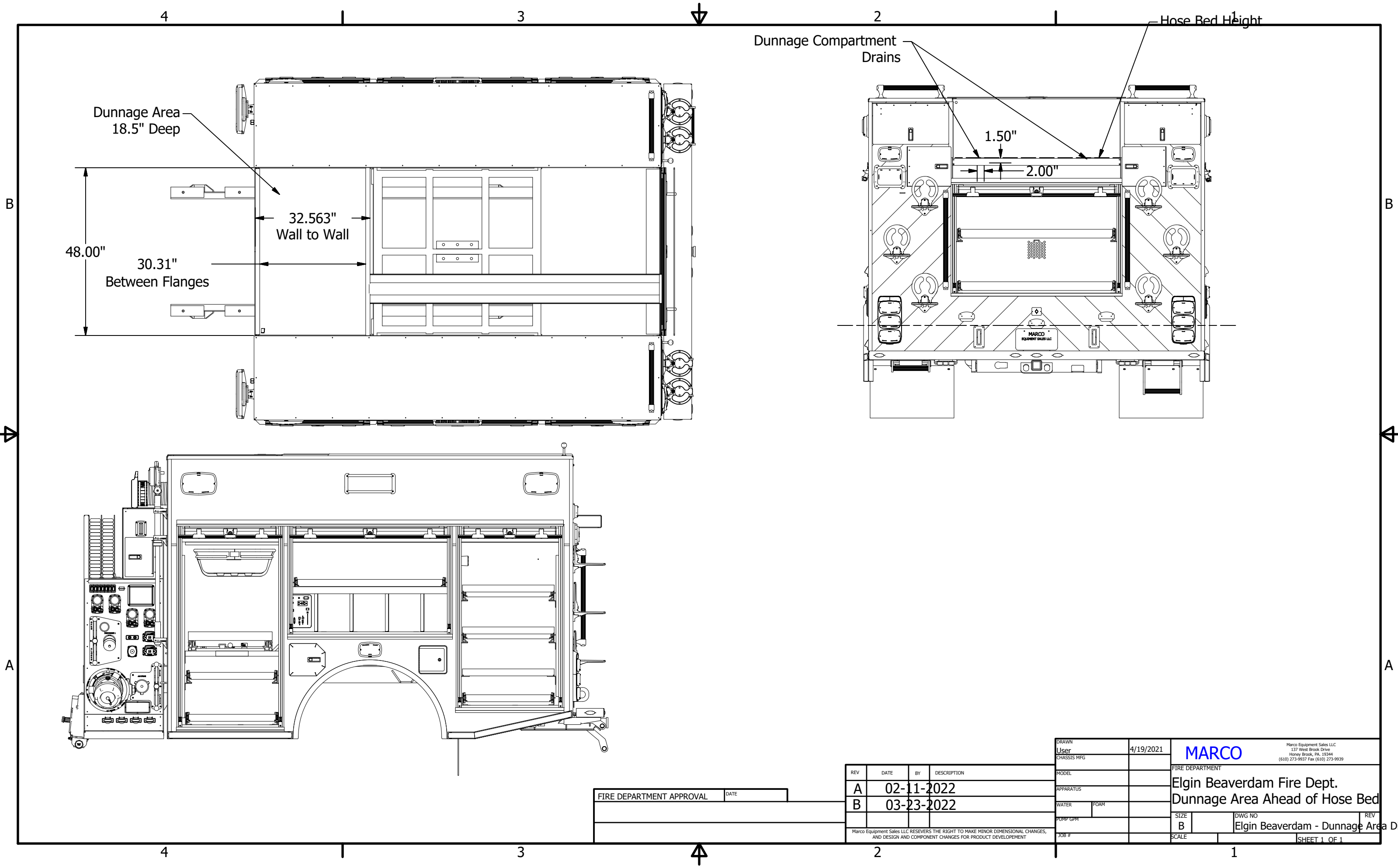

Dunnage Area  
18.5" Deep

48.00"  
30.31"  
Between Flanges

32.563"  
Wall to Wall

Dunnage Compartment  
Drains

1.50"

2.00"

Hose Bed Height

FIRE DEPARTMENT APPROVAL \_\_\_\_\_ DATE \_\_\_\_\_

REV	DATE	BY	DESCRIPTION
A	02-11-2022		
B	03-23-2022		

DRAWN User	4/19/2021	<b>MARCO</b> Marco Equipment Sales LLC 137 West Brook Drive Honey Brook, PA, 19344 (610) 273-9937 Fax (610) 273-9939
CHASSIS MFG		
MODEL		FIRE DEPARTMENT
APPARATUS		Elgin Beaverdam Fire Dept. Dunnage Area Ahead of Hose Bed
WATER	FOAM	SIZE
PUMP GPM		DWG NO
JOB #		Elgin Beaverdam - Dunnage Area Dime
		SCALE
		SHEET 1 OF 1

Marco Equipment Sales LLC RESEVES THE RIGHT TO MAKE MINOR DIMENSIONAL CHANGES,  
AND DESIGN AND COMPONENT CHANGES FOR PRODUCT DEVELOPMENT